

MDL

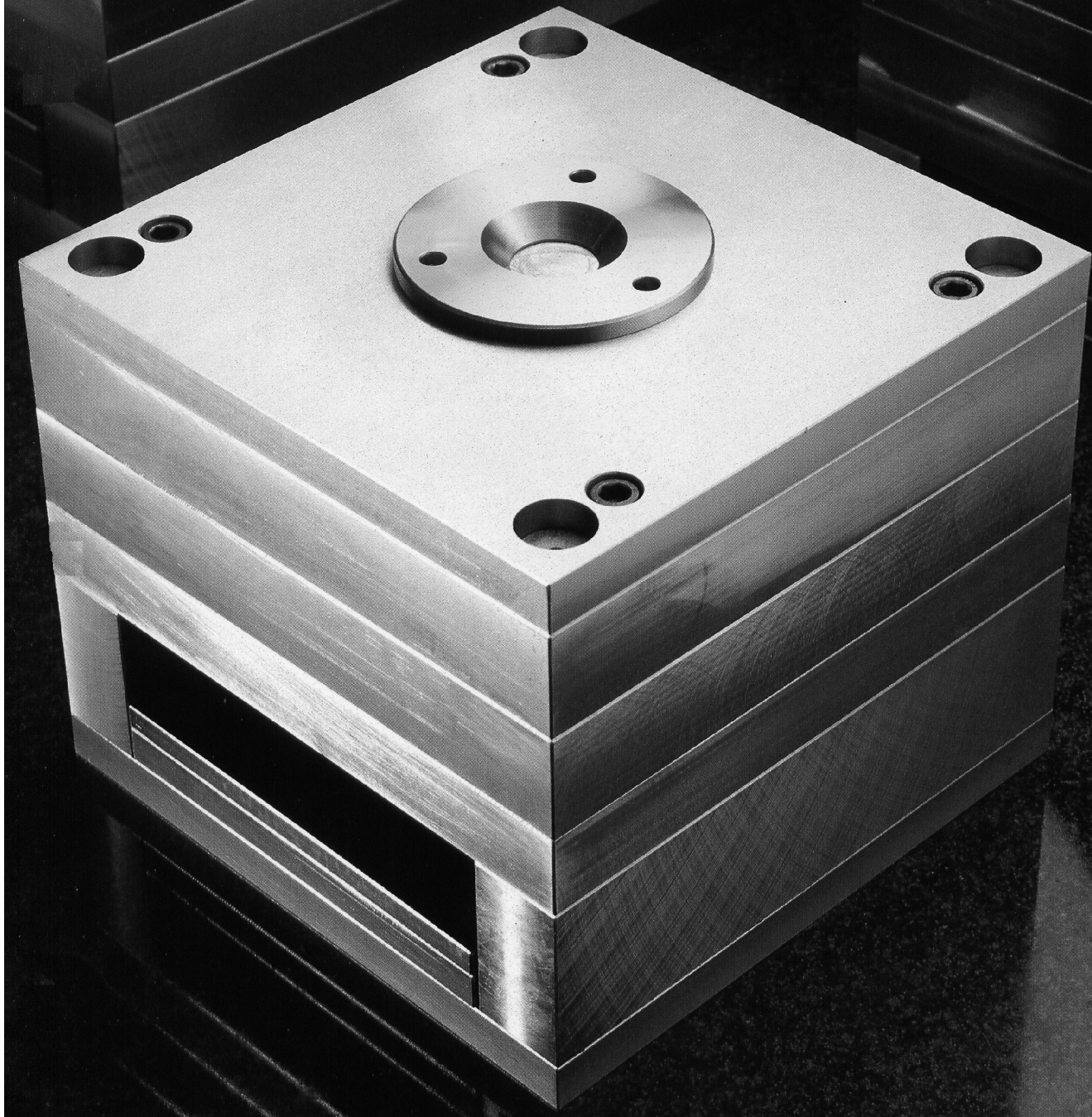

## NUANCES D'ACIERS

Code Matière	A	B	C	D	E
N° Matériaux	1.1730	1.2312	1.2311	1.2767	1.2162
Nuance AFNOR	XC 45	40 CMD8 + S	40 CMD8	45 NCD16	21 MC 5
Composition	C 0,45% Si 0,35% Mn 0,70% P+S 0,06%	C 0,40% Si 0,40% Mn 1,50% Cr 1,90% Mo 0,20% S 0,06%	C 0,40% Si 0,40% Mn 1,50% Cr 1,90% Mo 0,20%	C 0,45% Mn 0,40% Cr 1,40% Mo 0,30% Ni 4,1%	C 0,21% Si 0,25% Mn 1,30% Cr 1,20% P+S 0,06%
Résistance	Env. 640 N/mm <sup>2</sup>	Env. 1030 N/mm <sup>2</sup>	Env. 1030 N/mm <sup>2</sup>	Env. 830 N/mm <sup>2</sup>	Env. 650 N/mm <sup>2</sup>
Caractéristiques	Acier à outil non allié	Acier pré-traité usinage amélioré	Acier pré-traité 110 kg	Acier spécial durci à coeur	Acier standard à cémenter
Application	Eléments non trempés pour la fabrication de moules, outils, montage et pour l'usinage.	Plaques porte-empreintes pour la transformation des matières plastiques. Cadres de moules pour des moules à compression et injection	Plaques porte-empreintes pour la transformation des matières plastiques et facilitant le polissage.	Plaques porte-empreintes pour la transformation des matières plastiques. Pour des éléments soumis à de grands efforts de compression et de flexion.	Plaques porte-empreintes pour la transformation des matières plastiques.
Position	T11.T12.T13.T14. T31.T51.T61. T71.T81.	T11.T12.T13.T14. T31.T51. T81.	T31	T31	T31

## DENOMINATION

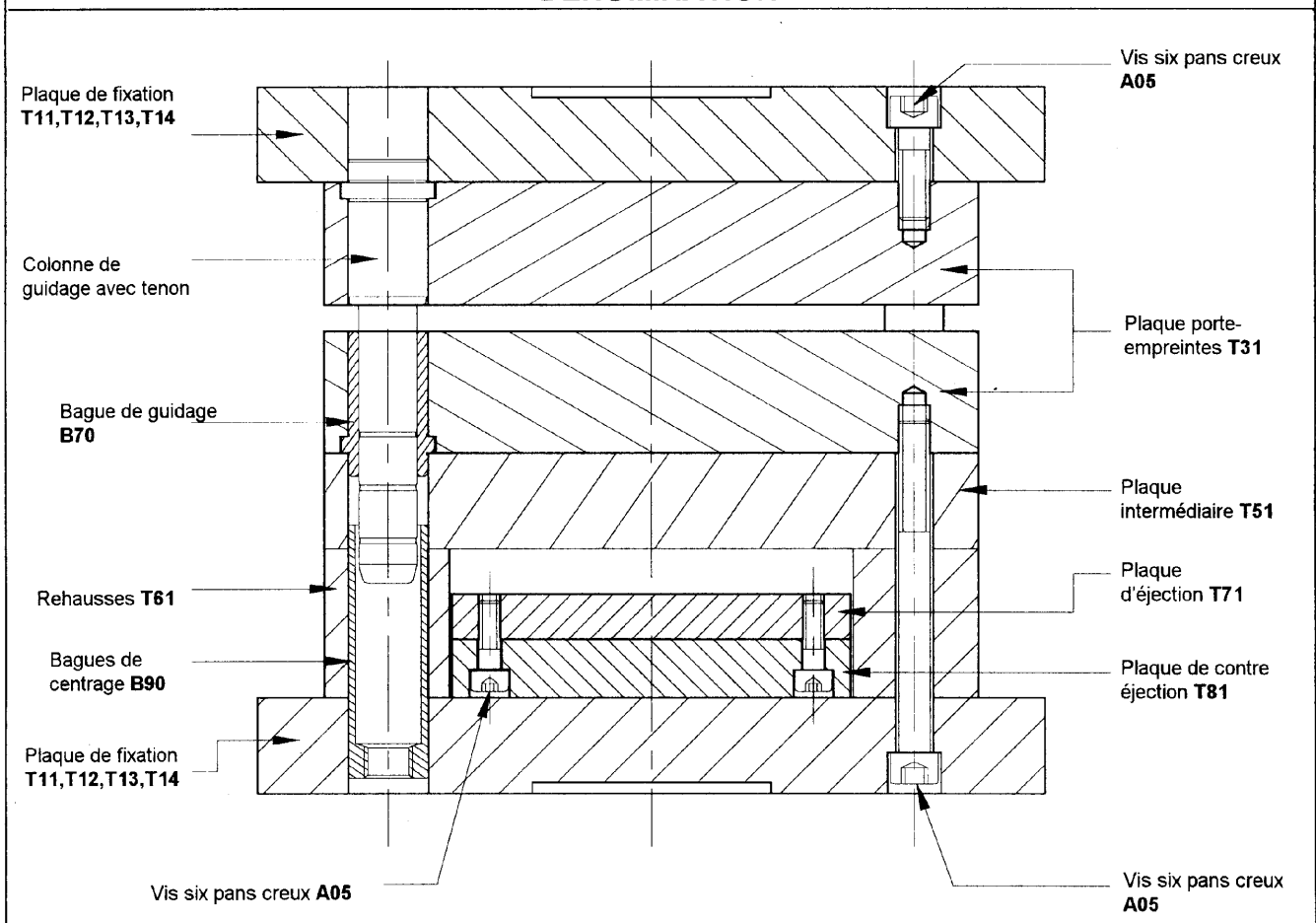

## EXEMPLE DE COMMANDE

T 31 . 24 34 . 056 B

Groupe de produits

Type

Dimensions

Code Matière

Epaisseur de la plaque



# CARCASSE COMPLETE

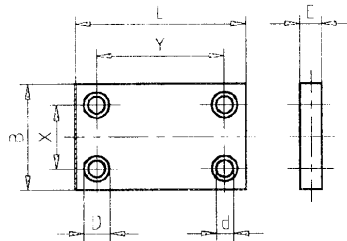
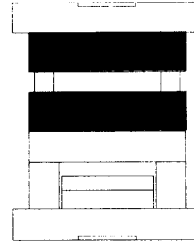

1515
1519
1524
1919
1924
1929
1934
2124
2129
2424
2429
2434
2439
2929
2934
2939
2944
2949
3434
3439
3444
3449
3939
3944
3949

	T31						E										
	B	L	D	d	X	Y	22	27	36	46	56	66	76	86	96	116	136
1515	156	156	20	14/15	122	122											
1519		196			120	156											
1524		246			122	212											
1919	196	196	26	18/20	154	152											
1924		246			154	202											
1929		296	30	22/24	150	244											
1934		346			150	294											
2124	218	246	26	18/20	176	202											
2129		296	30	22/24	172	244											
2424	246	246	30	22/24	200	200											
2429		296			200	244											
2434		346			194	294											
2439		396			198	340											
2929	296	296	30	22/24	250	244											
2934		346			244	224											
2939		396			248	340											
2944		446			244	394											
2949		496			244	444											
3434	346	346	30	22/24	294	294											
3439		396	42	30/32	274	316											
3444		446			274	374											
3449		496			274	416											
3939	396	396	42	30/32	324	324											
3944		446			324	374											
3949		496			324	424											

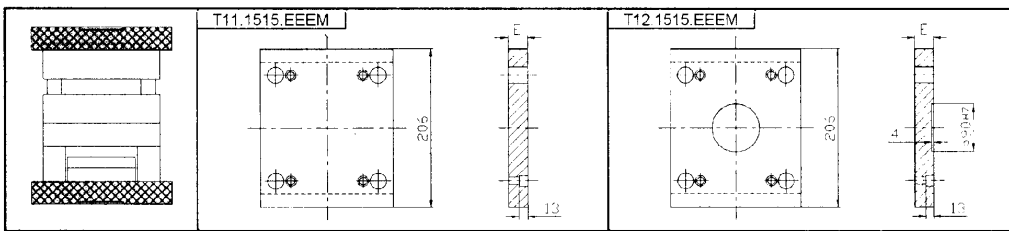
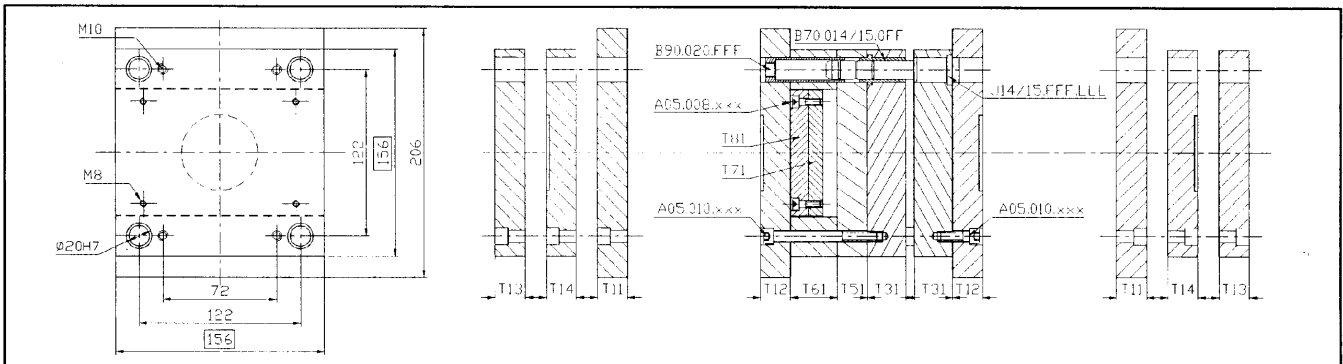

M	A	B	C	D	E
E	1730	2312	2311	2767	2162
22					
27					

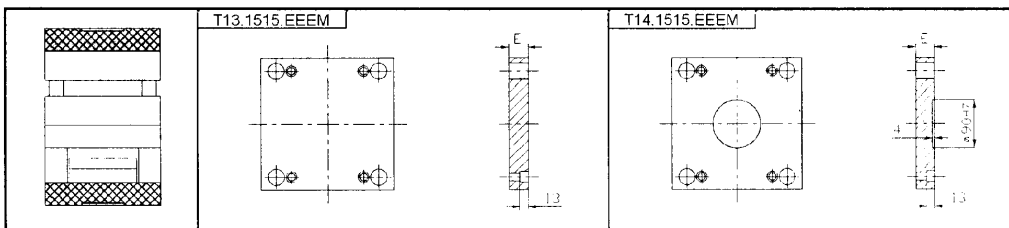

M	A	B	C	D	E
E	1730	2312	2311	2767	2162
17					
22					

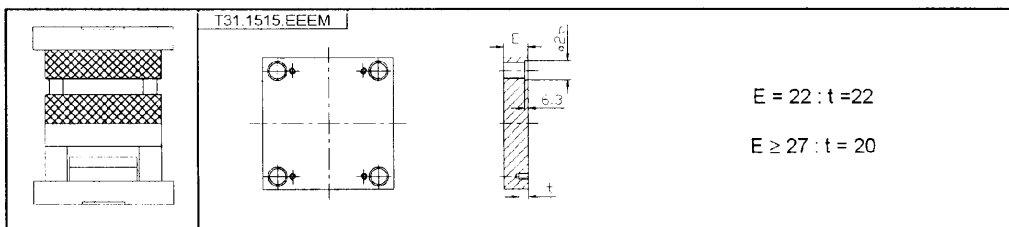

M	A	B	C	D	E
E	1730	2312	2311	2767	2162
22					
27					
36					
46					
56					
66					
76					

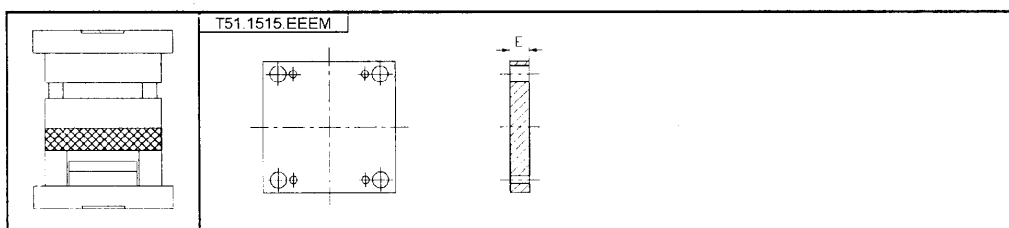

M	A	B	C	D	E
E	1730	2312	2311	2767	2162
27					
36					

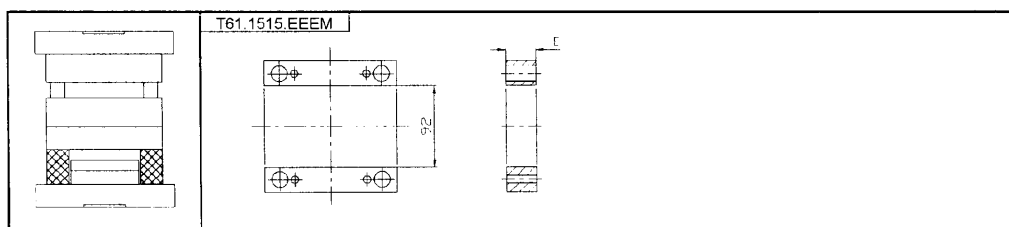

M	A	B	C	D	E
E	1730	2312	2311	2767	2162
46					
56					
76					

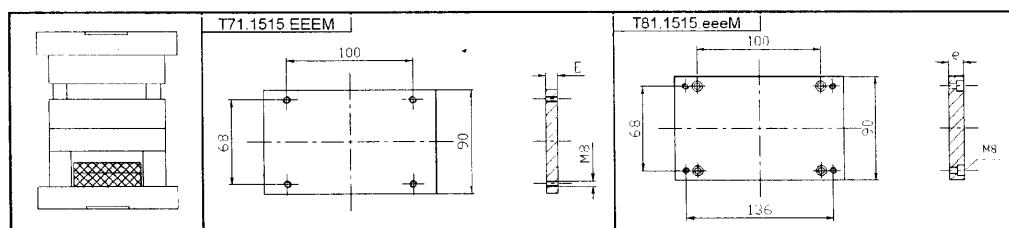

M	A	B	C	D	E
E	1730	2312	2311	2767	2162
9					





Ø 14 / Ø 15

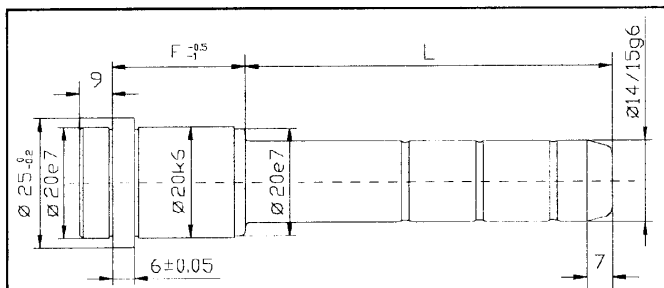

J14.FFF.LLL / J15.FFF.LLL					
F	L	Nr ø/Ø	F	L	Nr ø/Ø
22	30	J 14 / 15 .022.030	56	55	J 14 / 15 .056.055
	50	J 14 / 15 .022.050		75	J 14 / 15 .056.075
	70	J 14 / 15 .022.070		95	J 14 / 15 .056.095
27	30	J 14 / 15 .027.030	66	135	J 14 / 15 .056.135
	55	J 14 / 15 .027.055		55	J 14 / 15 .066.055
	85	J 14 / 15 .027.085		65	J 14 / 15 .066.065
36	105	J 14 / 15 .027.105	76	95	J 14 / 15 .066.095
	145	J 14 / 15 .027.145		125	J 14 / 15 .066.125
	35	J 14 / 15 .036.035		55	J 14 / 15 .076.055
46	55	J 14 / 15 .036.055	76	95	J 14 / 15 .076.095
	75	J 14 / 15 .036.075		105	J 14 / 15 .076.105
	95	J 14 / 15 .036.095		135	J 14 / 15 .076.135
46	125	J 14 / 15 .036.125			
	35	J 14 / 15 .046.035			
	45	J 14 / 15 .046.045			
	65	J 14 / 15 .046.065			
	105	J 14 / 15 .046.105			
	125	J 14 / 15 .046.125			

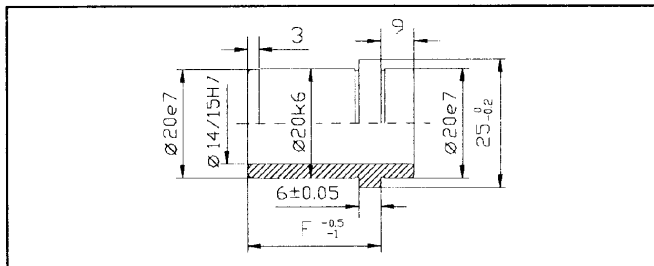

B70.014.0FF / B70.015.0FF			
F	Nr ø/Ø	F	Nr ø/Ø
22	B70.014/15.022	56	B70.014/15.056
27	B70.014/15.027	66	B70.014/15.066
36	B70.014/15.036	76	B70.014/15.076
46	B70.014/15.046		

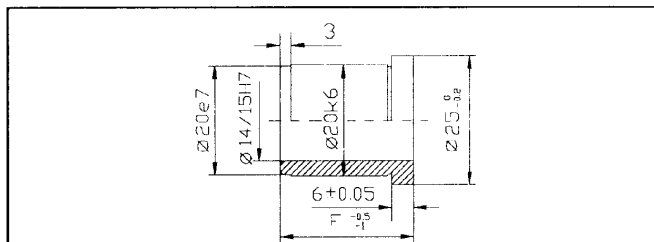

B80.014.0xx / B80.015.0FF			
F	Nr ø/Ø	F	Nr ø/Ø
22	B80.014/15.022	56	B80.014/15.056
27	B80.014/15.027	66	B80.014/15.066
36	B80.014/15.036	76	B80.014/15.076
46	B80.014/15.046		

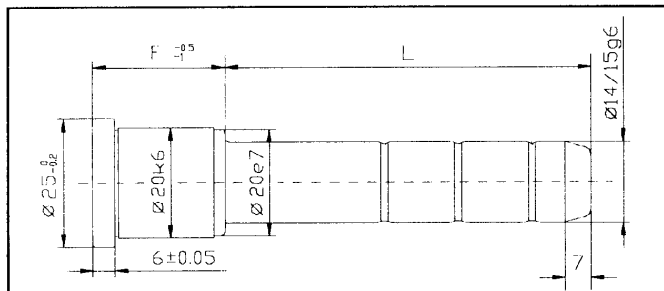

K14.FFF.LLL / K15.FFF.LLL					
F	L	Nr ø/Ø	F	L	Nr ø/Ø
22	35	K 14 / 15 .022.035	56	55	K 14 / 15 .056.055
	55	K 14 / 15 .022.055		75	K 14 / 15 .056.075
	70	K 14 / 15 .022.070		95	K 14 / 15 .056.095
27	30	K 14 / 15 .027.030	66		
	55	K 14 / 15 .027.055		55	K 14 / 15 .066.055
	85	K 14 / 15 .027.085		65	K 14 / 15 .066.065
36	105	K 14 / 15 .027.105	76	95	K 14 / 15 .066.095
	35	K 14 / 15 .036.035		55	K 14 / 15 .076.055
	55	K 14 / 15 .036.055		95	K 14 / 15 .076.095
46	75	K 14 / 15 .036.075	76	105	K 14 / 15 .076.105
	95	K 14 / 15 .036.095			
	35	K 14 / 15 .046.035			
	45	K 14 / 15 .046.045			
	65	K 14 / 15 .046.065			
	105	K 14 / 15 .046.105			

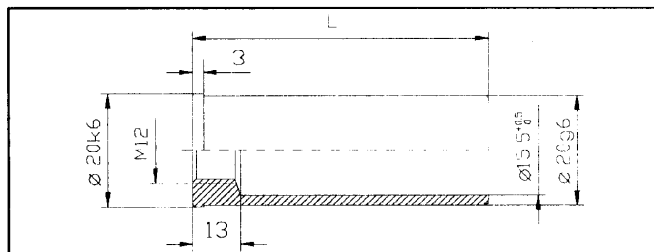

B90.020.LLL			
L	Nr	L	Nr
40	B90.020.040	100	B90.020.100
60	B90.020.060	120	B90.020.120
80	B90.020.080	140	B90.020.140

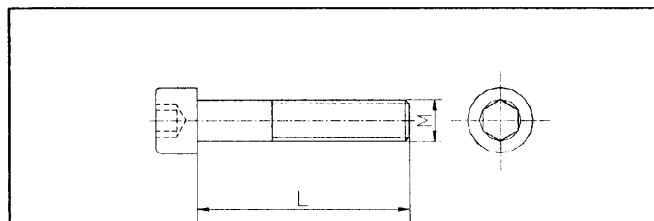

A05.xxx.xxx					
M x L	Nr	M x L	Nr	M x L	Nr
8x16	A05.008.016	10x35	A05.010.035	10x90	A05.010.090
		10x40	A05.010.040	10x100	A05.010.100
		10x45	A05.010.045	10x120	A05.010.120
		10x50	A05.010.050	10x130	A05.010.130
		10x55	A05.010.055	10x140	A05.010.140
		10x60	A05.010.060	10x150	A05.010.150
10x20	A05.010.020	10x65	A05.010.065	10x160	A05.010.160
10x25	A05.010.025	10x70	A05.010.070	10x180	A05.010.180
10x30	A05.010.030	10x80	A05.010.080	10x200	A05.010.200

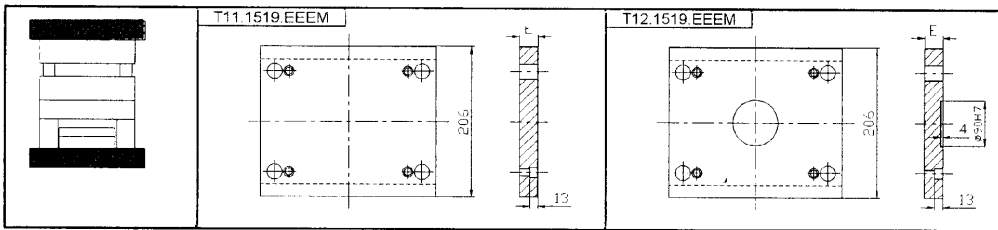
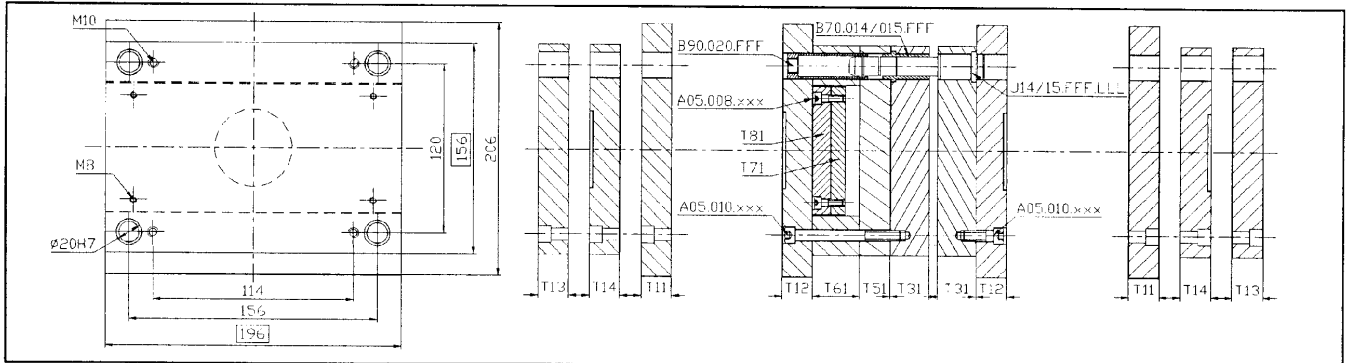

E	M	A	B	C	D	E
		1730	2312	2311	2767	2162
22						
27						

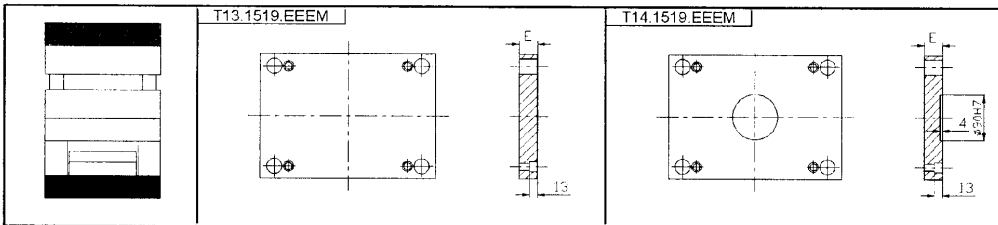

E	M	A	B	C	D	E
		1730	2312	2311	2767	2162
17						
22						

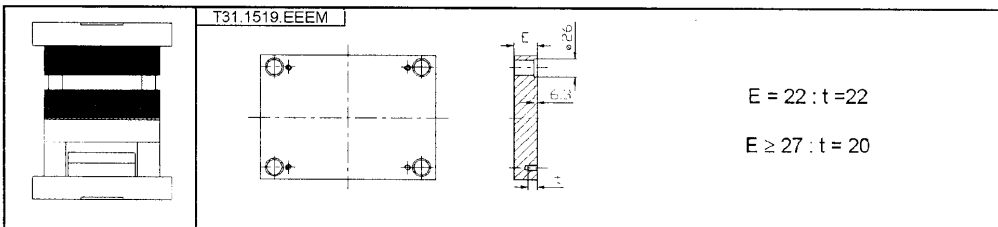

E	M	A	B	C	D	E
		1730	2312	2311	2767	2162
22						
27						
36						
46						
56						
66						
76						

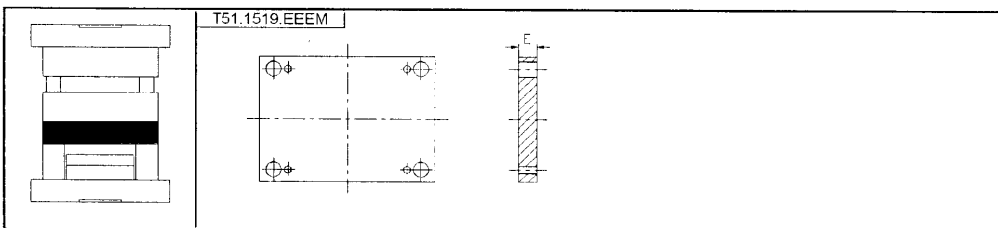

E	M	A	B	C	D	E
		1730	2312	2311	2767	2162
27						
36						

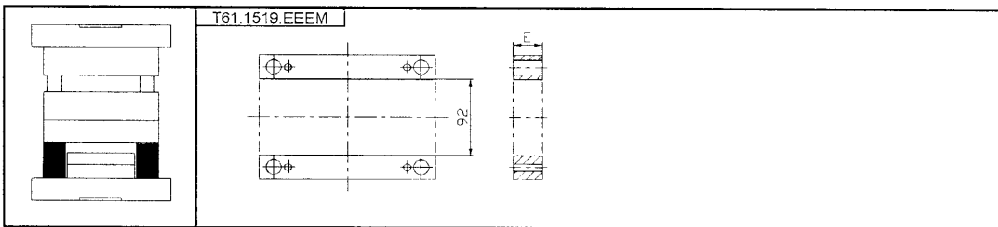

E	M	A	B	C	D	E
		1730	2312	2311	2767	2162
46						
56						
76						

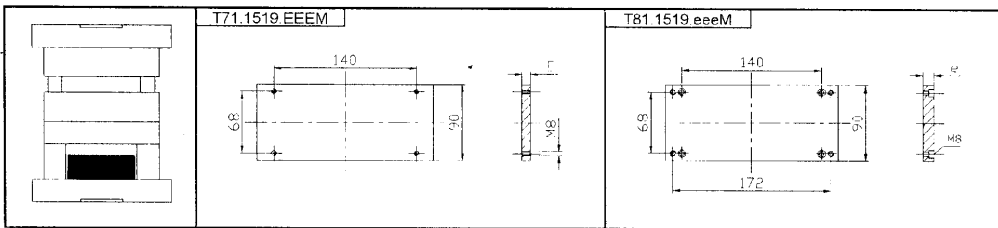

E	M	A	B	C	D	E
		1730	2312	2311	2767	2162
9						



Ø 14 / Ø 15

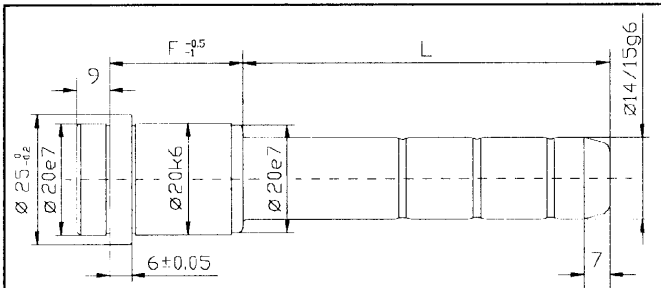
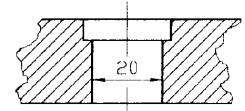

J14.FFF.LLL / J15.FFF.LLL					
F	L	Nr ø/Ø	F	L	Nr ø/Ø
22	30	J 14 / 15 022.030	56	55	J 14 / 15 056.055
	50	J 14 / 15 022.050		75	J 14 / 15 056.075
	70	J 14 / 15 022.070		95	J 14 / 15 056.095
27	30	J 14 / 15 027.030	66	135	J 14 / 15 056.135
	55	J 14 / 15 027.055		55	J 14 / 15 066.055
	85	J 14 / 15 027.085		65	J 14 / 15 066.065
36	105	J 14 / 15 027.105	76	95	J 14 / 15 066.095
	145	J 14 / 15 027.145		125	J 14 / 15 066.125
	35	J 14 / 15 036.035		55	J 14 / 15 076.055
46	55	J 14 / 15 036.055	76	95	J 14 / 15 076.095
	75	J 14 / 15 036.075		105	J 14 / 15 076.105
	95	J 14 / 15 036.095		135	J 14 / 15 076.135
36	125	J 14 / 15 036.125			
	35	J 14 / 15 046.035			
	45	J 14 / 15 046.045			
46	65	J 14 / 15 046.065			
	105	J 14 / 15 046.105			
	125	J 14 / 15 046.125			

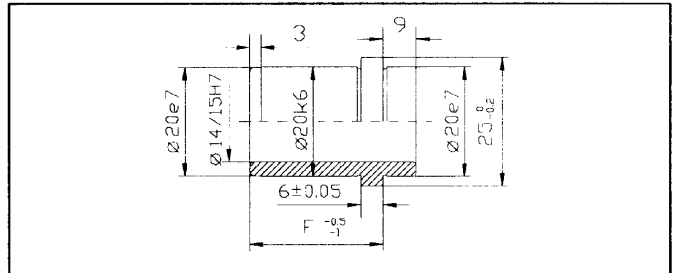

B70.014.OFF / B70.015.OFF			
F	Nr ø/Ø	F	Nr ø/Ø
22	B70.0 14 / 15 022	56	B70.0 14 / 15 056
27	B70.0 14 / 15 027	66	B70.0 14 / 15 066
36	B70.0 14 / 15 036	76	B70.0 14 / 15 076
46	B70.0 14 / 15 046		

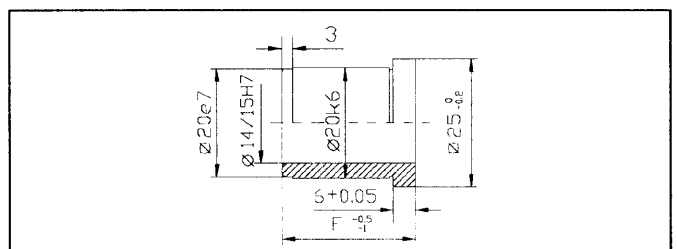

B80.014.0xx / B80.015.OFF			
F	Nr ø/Ø	F	Nr ø/Ø
22	B80.0 14 / 15 022	56	B80.0 14 / 15 056
27	B80.0 14 / 15 027	66	B80.0 14 / 15 066
36	B80.0 14 / 15 036	76	B80.0 14 / 15 076
46	B80.0 14 / 15 046		

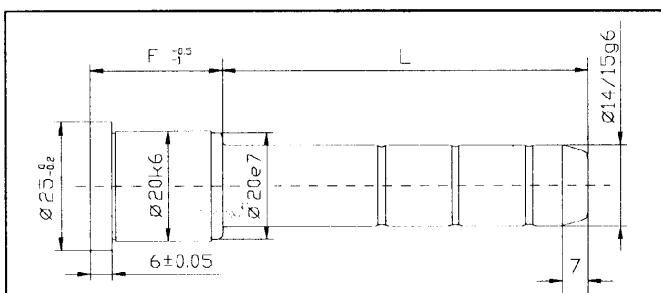

K14.FFF.LLL / K15.FFF.LLL					
F	L	Nr ø/Ø	F	L	Nr ø/Ø
22	35	K 14 / 15 022.035	56	55	K 14 / 15 056.055
	55	K 14 / 15 022.055		75	K 14 / 15 056.075
	70	K 14 / 15 022.070		95	K 14 / 15 056.095
27	30	K 14 / 15 027.030	66		
	55	K 14 / 15 027.055		55	K 14 / 15 066.055
	85	K 14 / 15 027.085		65	K 14 / 15 066.065
36	105	K 14 / 15 027.105	76	95	K 14 / 15 066.095
	35	K 14 / 15 036.035		55	K 14 / 15 076.055
	55	K 14 / 15 036.055		95	K 14 / 15 076.095
46	75	K 14 / 15 036.075			
	95	K 14 / 15 036.095			
	35	K 14 / 15 046.035			
46	45	K 14 / 15 046.045			
	65	K 14 / 15 046.065			
	105	K 14 / 15 046.105			

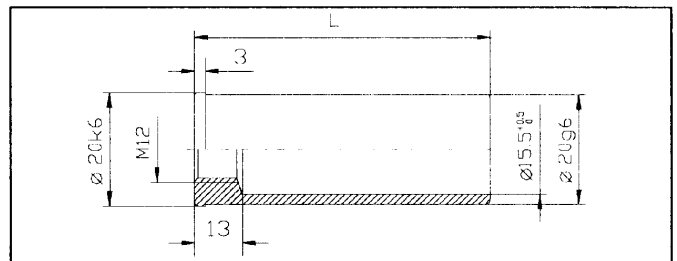

B90.020.LLL			
L	Nr	L	Nr
40	B90.020.040	100	B90.020.100
60	B90.020.060	120	B90.020.120
80	B90.020.080	140	B90.020.140

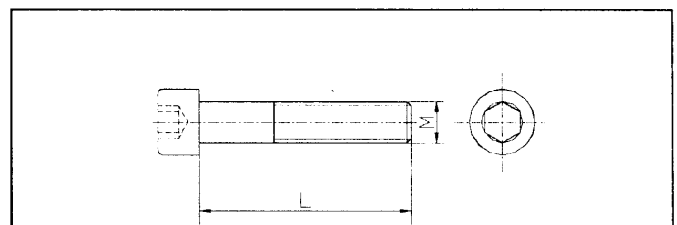

A05.xxx.xxx					
M x L	Nr	M x L	Nr	M x L	Nr
8x16	A05.008.016	10x35	A05.010.035	10x90	A05.010.090
		10x40	A05.010.040	10x100	A05.010.100
		10x45	A05.010.045	10x120	A05.010.120
		10x50	A05.010.050	10x130	A05.010.130
		10x55	A05.010.055	10x140	A05.010.140
10x20	A05.010.020	10x60	A05.010.060	10x150	A05.010.150
		10x65	A05.010.065	10x160	A05.010.160
		10x70	A05.010.070	10x180	A05.010.180
		10x75	A05.010.075	10x200	A05.010.200
		10x80	A05.010.080		

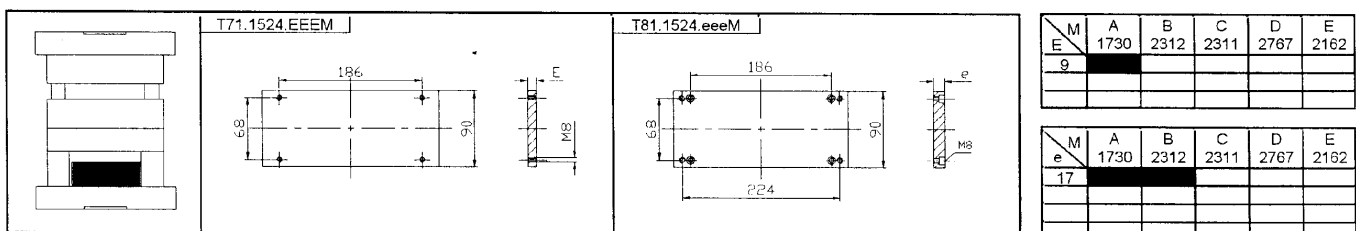
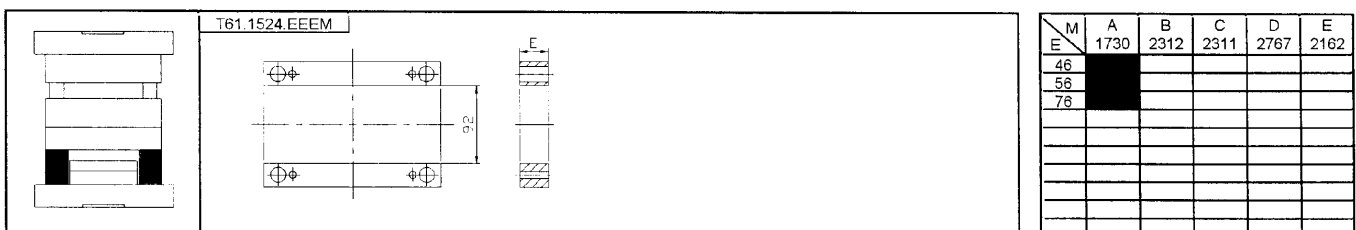
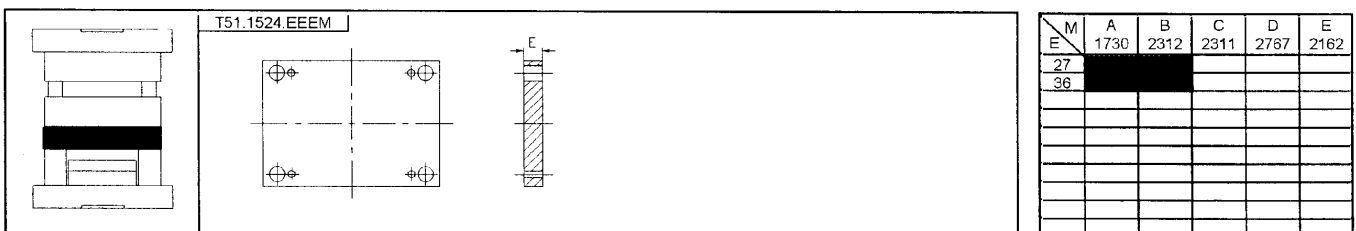
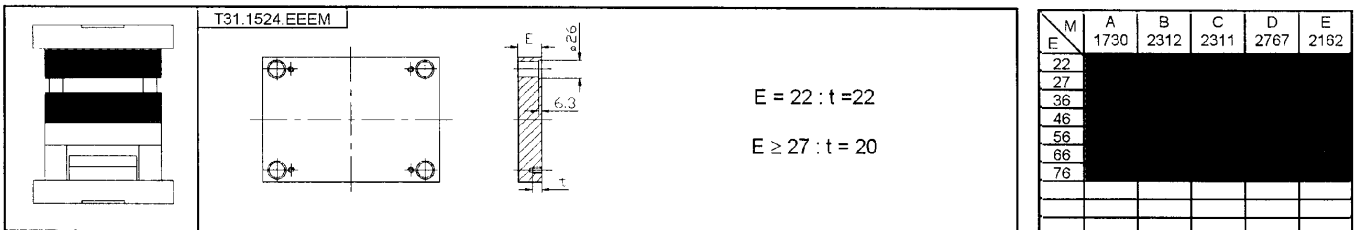
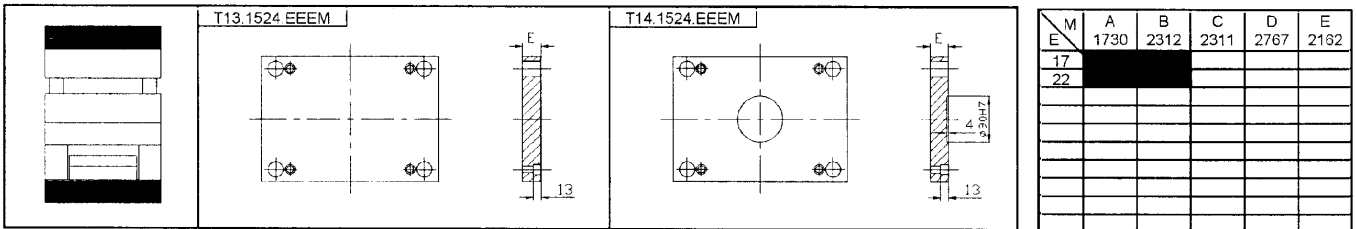
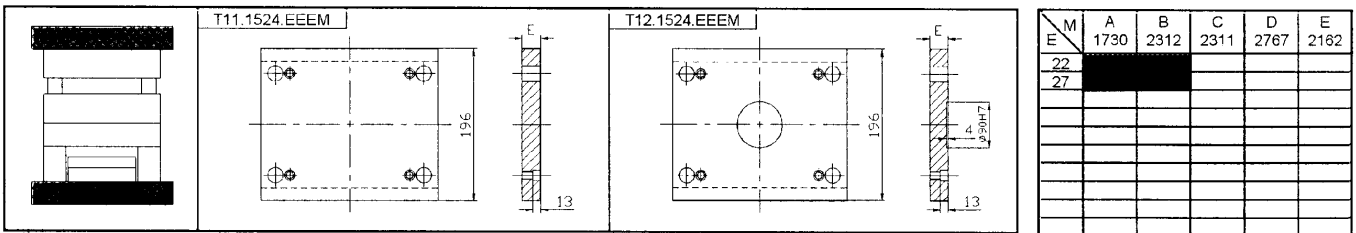
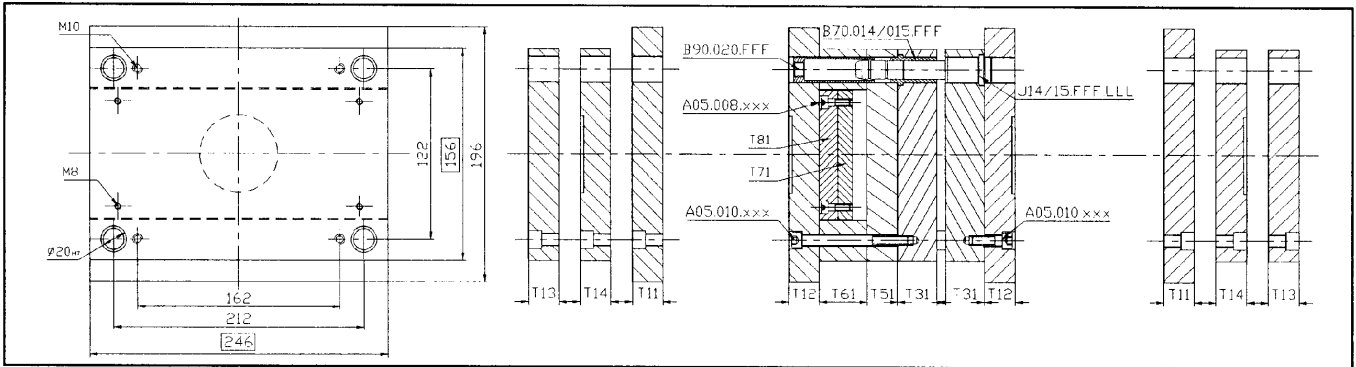



Ø 14 / Ø 15

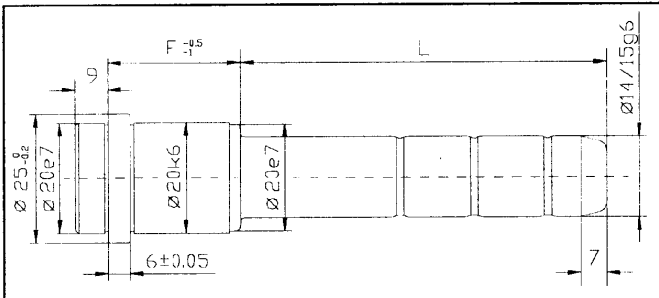
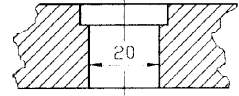

J14.FFF.LLL / J15.FFF.LLL							
F	L	Nr	Ø / Ø	F	L	Nr	Ø / Ø
22	30	J 14 / 15 .022.030		56	55	J 14 / 15 .056.055	
	50	J 14 / 15 .022.050			75	J 14 / 15 .056.075	
	70	J 14 / 15 .022.070			95	J 14 / 15 .056.095	
27	30	J 14 / 15 .027.030		66	135	J 14 / 15 .056.135	
	55	J 14 / 15 .027.055			55	J 14 / 15 .066.055	
	85	J 14 / 15 .027.085			65	J 14 / 15 .066.065	
36	105	J 14 / 15 .027.105		76	95	J 14 / 15 .066.095	
	145	J 14 / 15 .027.145			125	J 14 / 15 .066.125	
	35	J 14 / 15 .036.035			55	J 14 / 15 .076.055	
46	55	J 14 / 15 .036.055			95	J 14 / 15 .076.095	
	75	J 14 / 15 .036.075			105	J 14 / 15 .076.105	
	95	J 14 / 15 .036.095			135	J 14 / 15 .076.135	
	125	J 14 / 15 .036.125					
	35	J 14 / 15 .046.035					
	45	J 14 / 15 .046.045					
	65	J 14 / 15 .046.065					
	105	J 14 / 15 .046.105					
	125	J 14 / 15 .046.125					

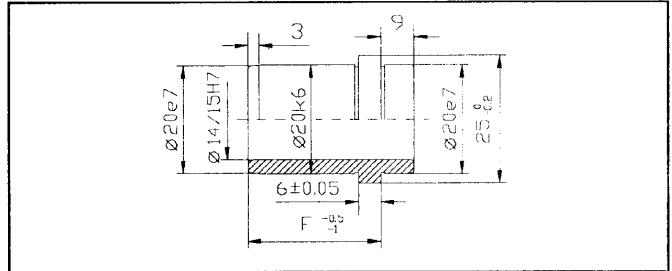

B70.014.OFF / B70.015.OFF					
F	Nr	Ø / Ø	Nr	Ø / Ø	
22	B70.0	14 / 15 .022	56	B70.0	14 / 15 .056
27	B70.0	14 / 15 .027	66	B70.0	14 / 15 .066
36	B70.0	14 / 15 .036	76	B70.0	14 / 15 .076
46	B70.0	14 / 15 .046			

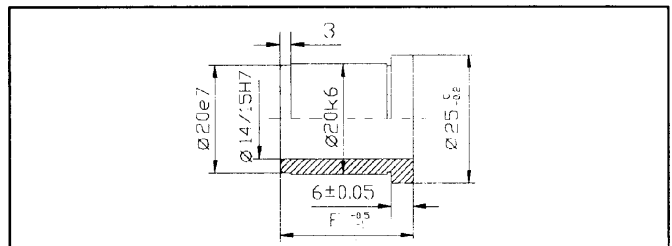

B80.014.0xx / B80.015.OFF					
F	Nr	Ø / Ø	F	Nr	Ø / Ø
22	B80.0	14 / 15 .022	56	B80.0	14 / 15 .056
27	B80.0	14 / 15 .027	66	B80.0	14 / 15 .066
36	B80.0	14 / 15 .036	76	B80.0	14 / 15 .076
46	B80.0	14 / 15 .046			

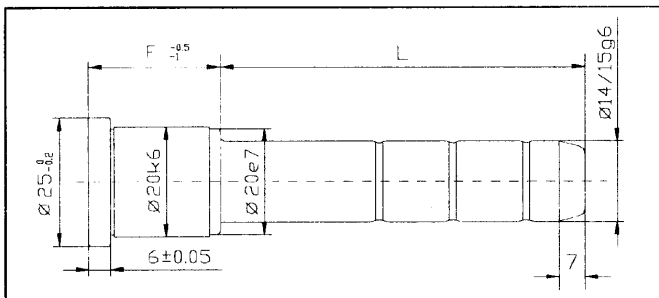

K14.FFF.LLL / K15.FFF.LLL								
F	L	Nr	Ø / Ø	F	L	Nr	Ø / Ø	
22	35	K 14 / 15 .022.035		56	55	K 14 / 15 .056.055		
	55	K 14 / 15 .022.055			75	K 14 / 15 .056.075		
	70	K 14 / 15 .022.070			95	K 14 / 15 .056.095		
27	30	K 14 / 15 .027.030		66				
	55	K 14 / 15 .027.055			55	K 14 / 15 .066.055		
	85	K 14 / 15 .027.085			65	K 14 / 15 .066.065		
36	105	K 14 / 15 .027.105		76	95	K 14 / 15 .066.095		
	35	K 14 / 15 .036.035			55	K 14 / 15 .076.055		
	55	K 14 / 15 .036.055			95	K 14 / 15 .076.095		
46	75	K 14 / 15 .036.075			105	K 14 / 15 .076.105		
	95	K 14 / 15 .036.095						
	35	K 14 / 15 .046.035						
	45	K 14 / 15 .046.045						
	85	K 14 / 15 .046.065						
	105	K 14 / 15 .046.105						

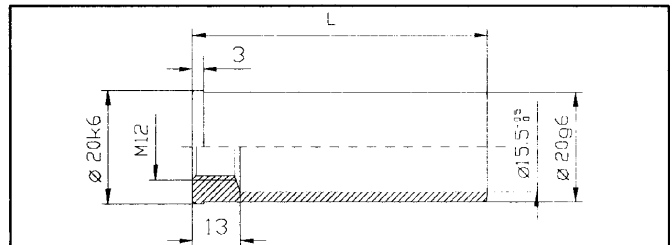

B90.020.LLL			
L	Nr	L	Nr
40	B90.020.040	100	B90.020.100
60	B90.020.060	120	B90.020.120
80	B90.020.080	140	B90.020.140

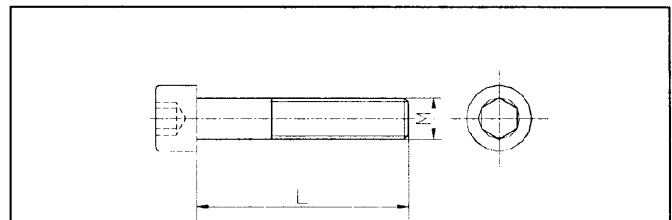

A05.xxx.xxx					
M x L	Nr	M x L	Nr	M x L	Nr
8x16	A05.008.016	10x35	A05.010.035	10x90	A05.010.090
		10x40	A05.010.040	10x100	A05.010.100
		10x45	A05.010.045	10x120	A05.010.120
		10x50	A05.010.050	10x130	A05.010.130
10x20	A05.010.020	10x55	A05.010.055	10x140	A05.010.140
		10x60	A05.010.060	10x150	A05.010.150
		10x65	A05.010.065	10x160	A05.010.160
		10x70	A05.010.070	10x180	A05.010.180
10x25	A05.010.025	10x70	A05.010.070	10x180	A05.010.180
10x30	A05.010.030	10x80	A05.010.080	10x200	A05.010.200

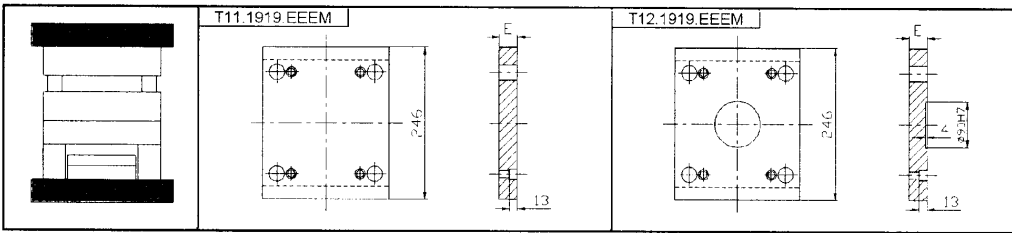
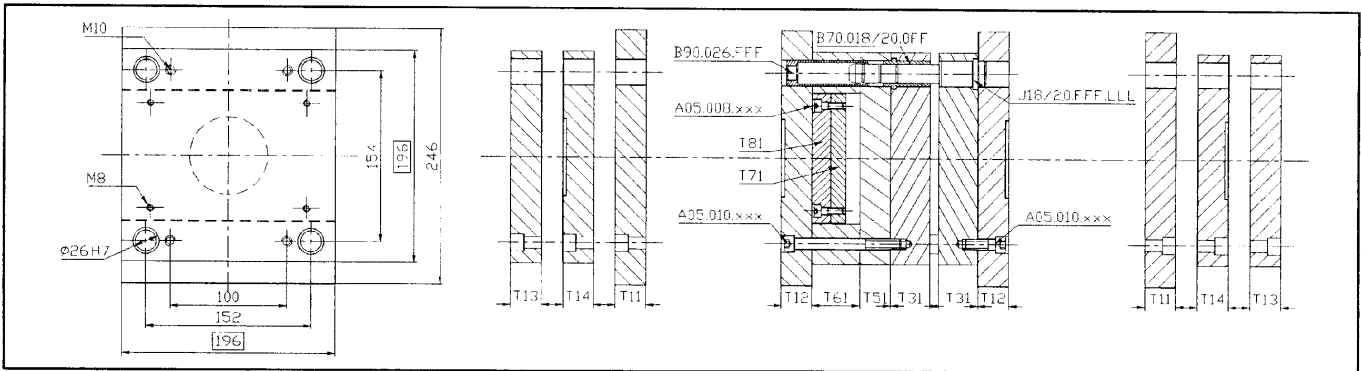

M	A	B	C	D	E
E	1730	2312	2311	2767	2162
22					
27					

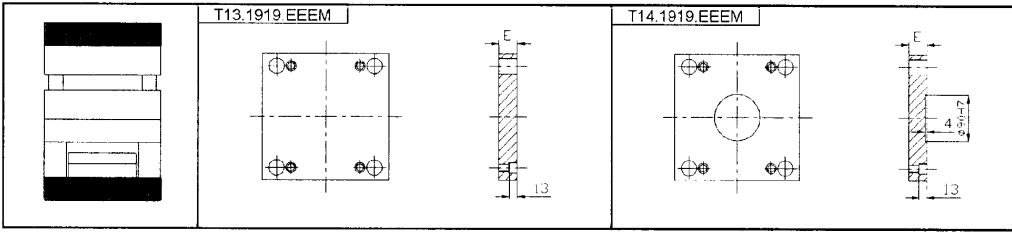

M	A	B	C	D	E
E	1730	2312	2311	2767	2162
17					
22					

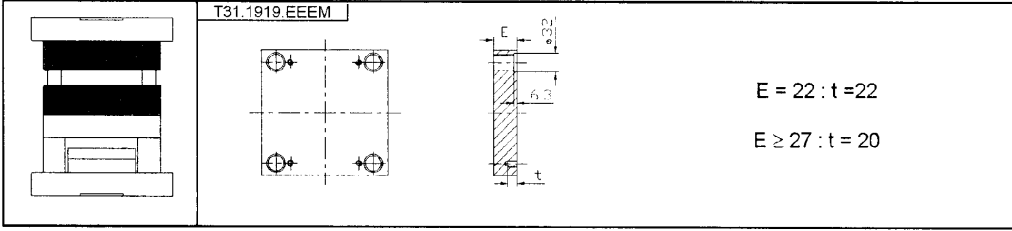

M	A	B	C	D	E
E	1730	2312	2311	2767	2162
22					
27					
36					
46					
56					
66					
76					
86					
96					

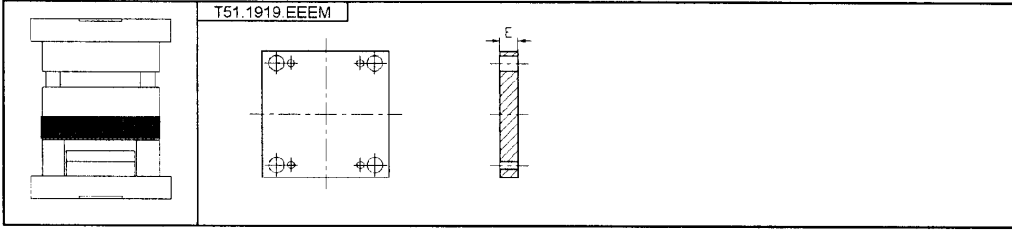

M	A	B	C	D	E
E	1730	2312	2311	2767	2162
27					
36					

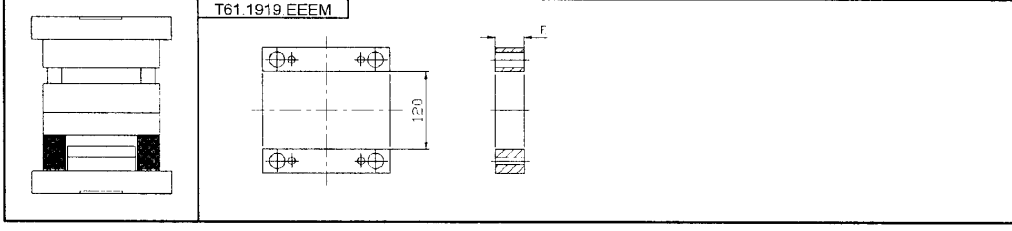

M	A	B	C	D	E
E	1730	2312	2311	2767	2162
46					
56					
76					

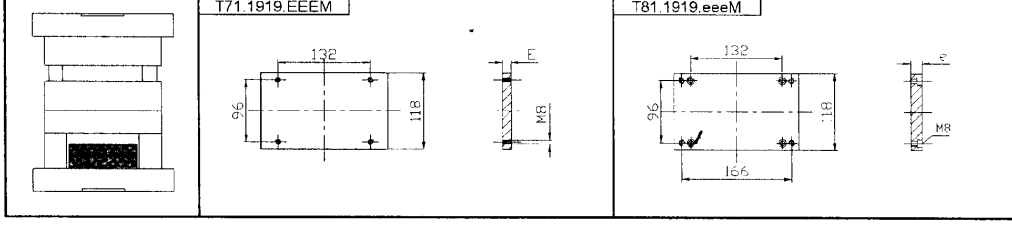

M	A	B	C	D	E
E	1730	2312	2311	2767	2162
12					

  

e	M	A	B	C	D	E
17						





Ø 18 / Ø 20

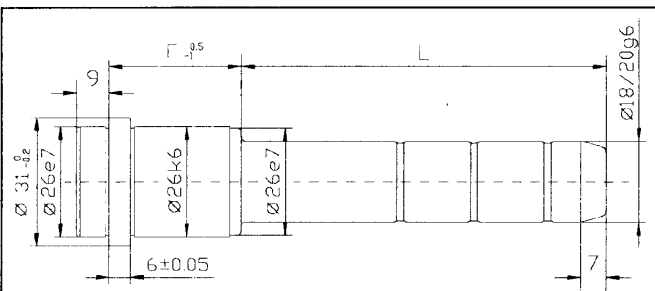
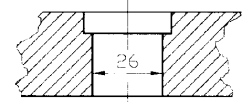

J18.FFF.LLL / J20.FFF.LLL					
F	L	Nr $\varnothing/\varnothing$	F	L	Nr $\varnothing/\varnothing$
22	35	J 18 / 20 .022.035	56	55	J 18 / 20 .056.055
	45	J 18 / 20 .022.045		75	J 18 / 20 .056.075
	85	J 18 / 20 .022.085		95	J 18 / 20 .056.095
27	35	J 18 / 20 .027.035	66	155	J 18 / 20 .056.135
	45	J 18 / 20 .027.045		55	J 18 / 20 .066.055
	65	J 18 / 20 .027.065		75	J 18 / 20 .066.075
	105	J 18 / 20 .027.105		95	J 18 / 20 .066.095
	125	J 18 / 20 .027.125		145	J 18 / 20 .066.145
36	185	J 18 / 20 .027.185	76	55	J 18 / 20 .076.055
	35	J 18 / 20 .036.035		75	J 18 / 20 .076.075
	55	J 18 / 20 .036.055		95	J 18 / 20 .076.095
	75	J 18 / 20 .036.075		135	J 18 / 20 .076.135
	115	J 18 / 20 .036.115		75	J 18 / 20 .086.075
46	135	J 18 / 20 .036.135	86	95	J 18 / 20 .086.095
	165	J 18 / 20 .036.165		125	J 18 / 20 .086.125
	35	J 18 / 20 .046.035		75	J 18 / 20 .096.075
	45	J 18 / 20 .046.045		95	J 18 / 20 .096.095
	65	J 18 / 20 .046.065		135	J 18 / 20 .096.135
	105	J 18 / 20 .046.105			
	135	J 18 / 20 .046.135			
	165	J 18 / 20 .046.165			

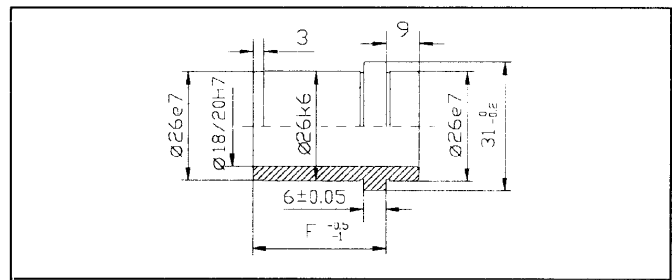

B70.018.OFF / B70.020.OFF			
F	Nr $\varnothing/\varnothing$	F	Nr $\varnothing/\varnothing$
22	B70.0 18 / 20 .022	66	B70.0 18 / 20 .066
27	B70.0 18 / 20 .027	76	B70.0 18 / 20 .076
36	B70.0 18 / 20 .036	86	B70.0 18 / 20 .086
46	B70.0 18 / 20 .046	96	B70.0 18 / 20 .096
56	B70.0 18 / 20 .056		

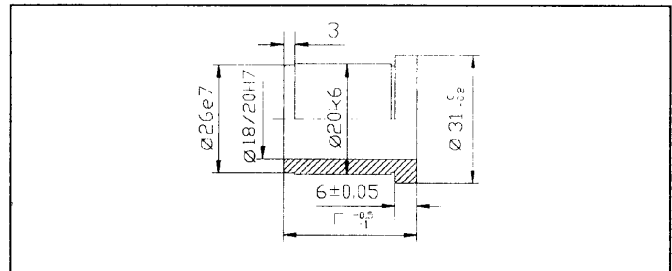

B80.018.OFF / B80.020.OFF			
F	Nr $\varnothing/\varnothing$	F	Nr $\varnothing/\varnothing$
22	B80.0 18 / 20 .022	66	B80.0 18 / 20 .066
27	B80.0 18 / 20 .027	76	B80.0 18 / 20 .076
36	B80.0 18 / 20 .036	86	B80.0 18 / 20 .086
46	B80.0 18 / 20 .046	96	B80.0 18 / 20 .096
56	B80.0 18 / 20 .056		

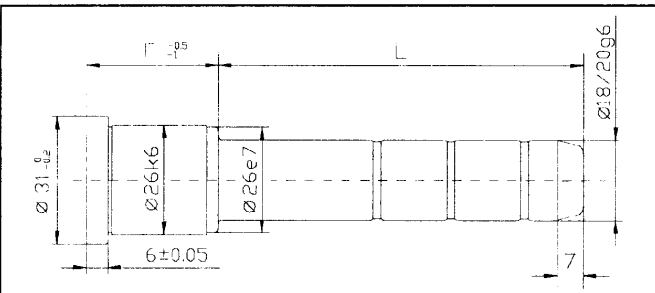

K18.FFF.LLL / K20.FFF.LLL					
F	L	Nr $\varnothing/\varnothing$	F	L	Nr $\varnothing/\varnothing$
22	35	K 18 / 20 .022.035	56	55	K 18 / 20 .056.055
	55	K 18 / 20 .022.055		75	K 18 / 20 .056.075
	85	K 18 / 20 .022.085		95	K 18 / 20 .056.095
27	35	K 18 / 20 .027.035	66	55	K 18 / 20 .066.055
	45	K 18 / 20 .027.045		75	K 18 / 20 .066.075
	65	K 18 / 20 .027.065		95	K 18 / 20 .066.095
	105	K 18 / 20 .027.105			
	125	K 18 / 20 .027.125			
36	185	K 18 / 20 .027.185	76	55	K 18 / 20 .076.055
	35	K 18 / 20 .036.035		75	K 18 / 20 .076.075
	55	K 18 / 20 .036.055		95	K 18 / 20 .076.095
	75	K 18 / 20 .036.075			
	115	K 18 / 20 .036.115		75	K 18 / 20 .086.075
46	135	K 18 / 20 .036.135	86	95	K 18 / 20 .086.095
	45	K 18 / 20 .046.045		75	K 18 / 20 .096.075
	65	K 18 / 20 .046.065		95	K 18 / 20 .096.095
	85	K 18 / 20 .046.085			
	105	K 18 / 20 .046.105			
	135	K 18 / 20 .046.135			

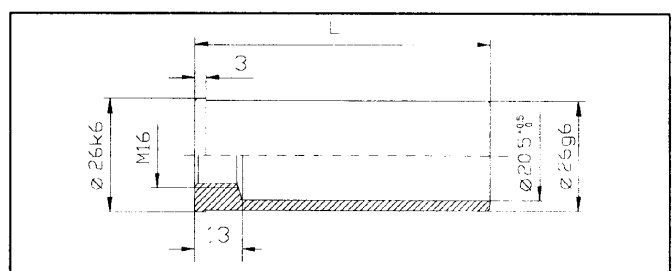

B90.026.LLL			
L	Nr	L	Nr
40	B90.026.040	100	B90.026.100
60	B90.026.060	120	B90.026.120
80	B90.026.080	140	B90.026.140

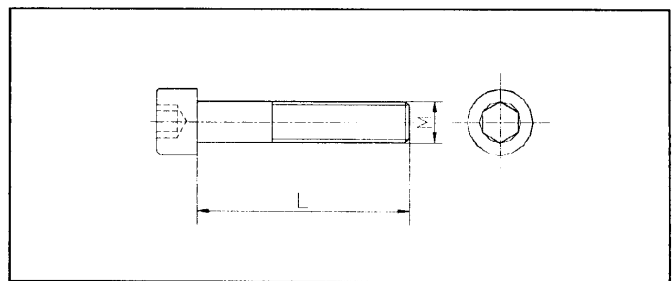

A05.xxx.xxx					
M x L	Nr	M x L	Nr	M x L	Nr
8x16	A05.008.016	10x35	A05.010.035	10x90	A05.010.090
		10x40	A05.010.040	10x100	A05.010.100
		10x45	A05.010.045	10x120	A05.010.120
		10x50	A05.010.050	10x130	A05.010.130
		10x55	A05.010.055	10x140	A05.010.140
10x20	A05.010.020	10x60	A05.010.060	10x150	A05.010.150
		10x65	A05.010.065	10x160	A05.010.160
		10x70	A05.010.070	10x180	A05.010.180
		10x75	A05.010.075	10x200	A05.010.200
		10x80	A05.010.080		

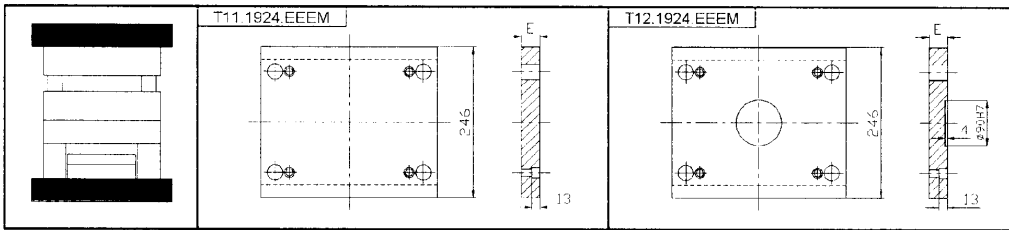
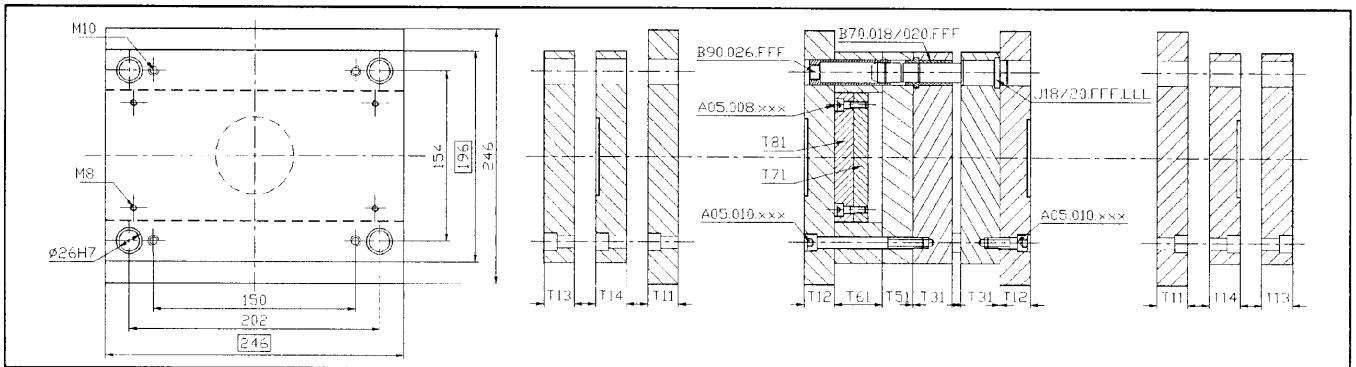

M	A	B	C	D	E
E	1730	2312	2311	2767	2162
22					
27					

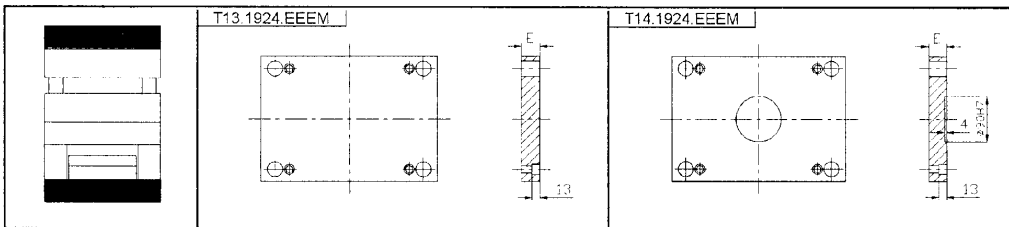

M	A	B	C	D	E
E	1730	2312	2311	2767	2162
17					
22					

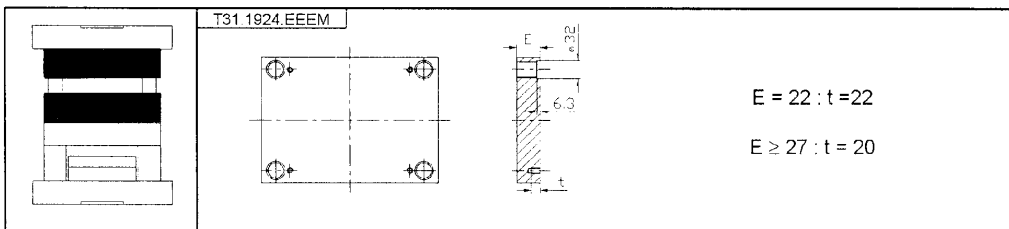

M	A	B	C	D	E
E	1730	2312	2311	2767	2162
22					
27					
36					
46					
56					
66					
76					
86					
96					

E = 22 : t = 22  
E ≥ 27 : t = 20

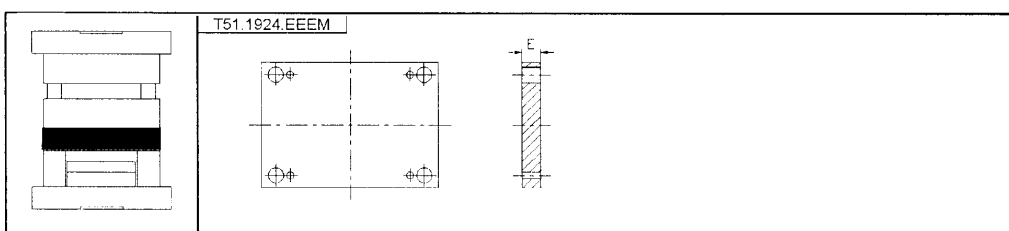

M	A	B	C	D	E
E	1730	2312	2311	2767	2162
27					
36					

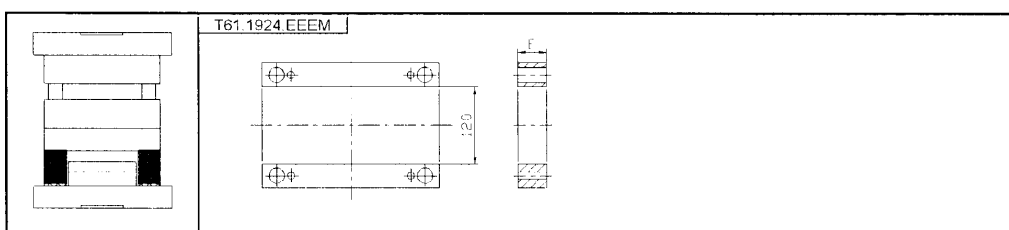

M	A	B	C	D	E
E	1730	2312	2311	2767	2162
46					
56					
76					

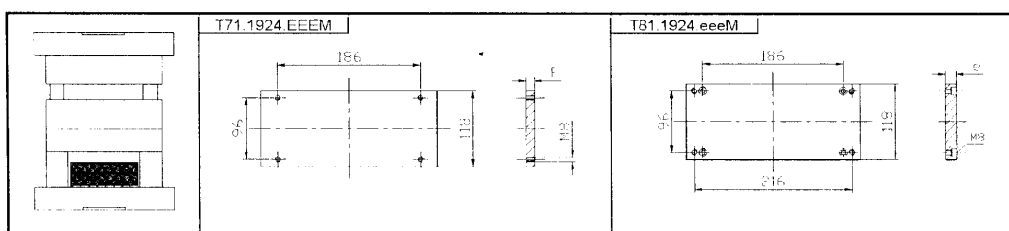

M	A	B	C	D	E
E	1730	2312	2311	2767	2162
12					



Ø 18 / Ø 20

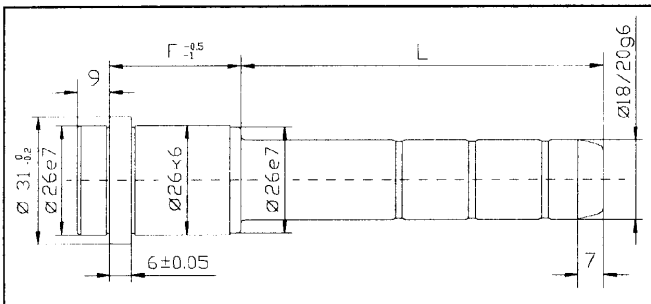

J18.FFF.LLL / J20.FFF.LLL					
F	L	Nr ø/Ø	F	L	Nr ø/Ø
22	35	J 18 / 20 .022.035	56	55	J 18 / 20 .056.055
	45	J 18 / 20 .022.045		75	J 18 / 20 .056.075
	85	J 18 / 20 .022.085		95	J 18 / 20 .056.095
27	35	J 18 / 20 .027.035	66	155	J 18 / 20 .056.135
	45	J 18 / 20 .027.045		55	J 18 / 20 .066.055
	65	J 18 / 20 .027.065		75	J 18 / 20 .066.075
	105	J 18 / 20 .027.105		95	J 18 / 20 .066.095
	125	J 18 / 20 .027.125		145	J 18 / 20 .066.145
36	165	J 18 / 20 .027.165	86	55	J 18 / 20 .076.055
	35	J 18 / 20 .036.035		75	J 18 / 20 .076.075
	55	J 18 / 20 .036.055		95	J 18 / 20 .076.095
	75	J 18 / 20 .036.075		135	J 18 / 20 .076.135
	115	J 18 / 20 .036.115		75	J 18 / 20 .086.075
46	135	J 18 / 20 .036.135	96	95	J 18 / 20 .086.095
	165	J 18 / 20 .036.165		125	J 18 / 20 .086.125
	35	J 18 / 20 .046.035		75	J 18 / 20 .096.075
	45	J 18 / 20 .046.045		95	J 18 / 20 .096.095
	65	J 18 / 20 .046.065		135	J 18 / 20 .096.135

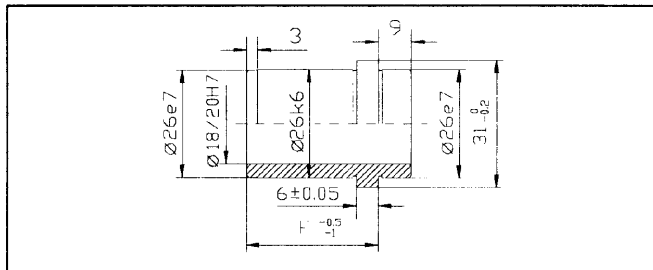

B70.018.OFF / B70.020.OFF			
F	Nr ø/Ø	F	Nr ø/Ø
22	B70.018/20.022	66	B70.018/20.066
27	B70.018/20.027	76	B70.018/20.076
36	B70.018/20.036	86	B70.018/20.086
46	B70.018/20.046	96	B70.018/20.096
56	B70.018/20.056		

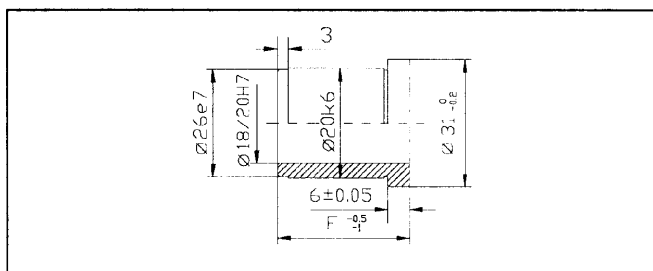

B80.018.OFF / B80.020.OFF			
F	Nr ø/Ø	F	Nr ø/Ø
22	B80.018/20.022	66	B80.018/20.066
27	B80.018/20.027	76	B80.018/20.076
36	B80.018/20.036	86	B80.018/20.086
46	B80.018/20.046	96	B80.018/20.096
56	B80.018/20.056		

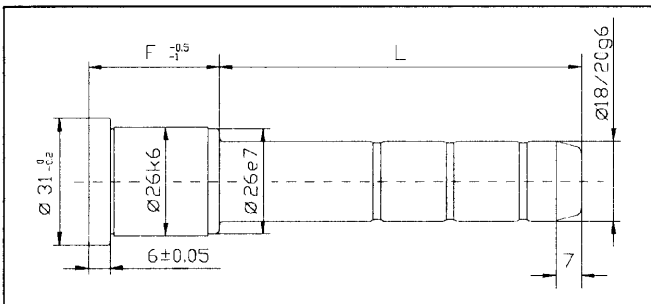

K18.FFF.LLL / K20.FFF.LLL					
F	L	Nr ø/Ø	F	L	Nr ø/Ø
22	35	K 18 / 20 .022.035	56	55	K 18 / 20 .056.055
	55	K 18 / 20 .022.055		75	K 18 / 20 .056.075
	85	K 18 / 20 .022.085		95	K 18 / 20 .056.095
27	35	K 18 / 20 .027.035	66	55	K 18 / 20 .066.055
	45	K 18 / 20 .027.045		75	K 18 / 20 .066.075
	65	K 18 / 20 .027.065		95	K 18 / 20 .066.095
	105	K 18 / 20 .027.105			
	125	K 18 / 20 .027.125			
36	165	K 18 / 20 .027.165	86	55	K 18 / 20 .076.055
	35	K 18 / 20 .036.035		75	K 18 / 20 .076.075
	55	K 18 / 20 .036.055		95	K 18 / 20 .076.095
	75	K 18 / 20 .036.075			
	115	K 18 / 20 .036.115			
46	135	K 18 / 20 .036.135	96	75	K 18 / 20 .086.075
	45	K 18 / 20 .046.045		95	K 18 / 20 .086.095
	65	K 18 / 20 .046.065			
	85	K 18 / 20 .046.085			
	105	K 18 / 20 .046.105			

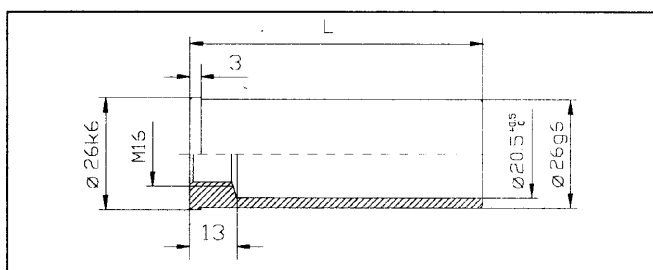

B90.026.LLL			
L	Nr	L	Nr
40	B90.026.040	100	B90.026.100
60	B90.026.060	120	B90.026.120
80	B90.026.080	140	B90.026.140

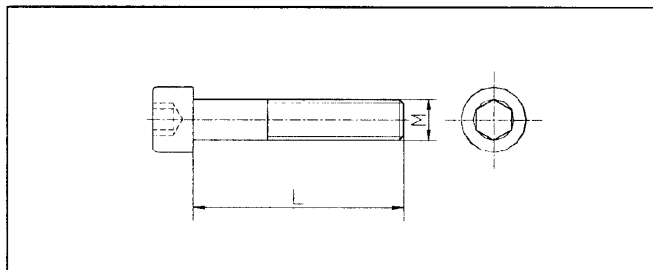

A05.xxx.xxx					
M x L	Nr	M x L	Nr	M x L	Nr
8x16	A05.008.016	10x35	A05.010.035	10x90	A05.010.090
		10x40	A05.010.040	10x100	A05.010.100
		10x45	A05.010.045	10x120	A05.010.120
		10x50	A05.010.050	10x130	A05.010.130
		10x55	A05.010.055	10x140	A05.010.140
10x20	A05.010.020	10x60	A05.010.060	10x150	A05.010.150
		10x65	A05.010.065	10x160	A05.010.160
		10x70	A05.010.070	10x180	A05.010.180
		10x75	A05.010.075	10x200	A05.010.200
		10x80	A05.010.080		

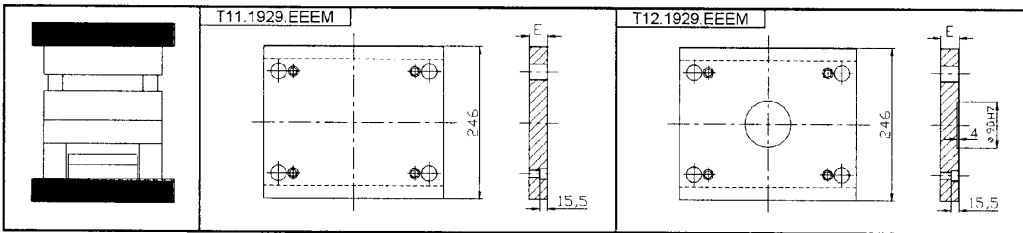
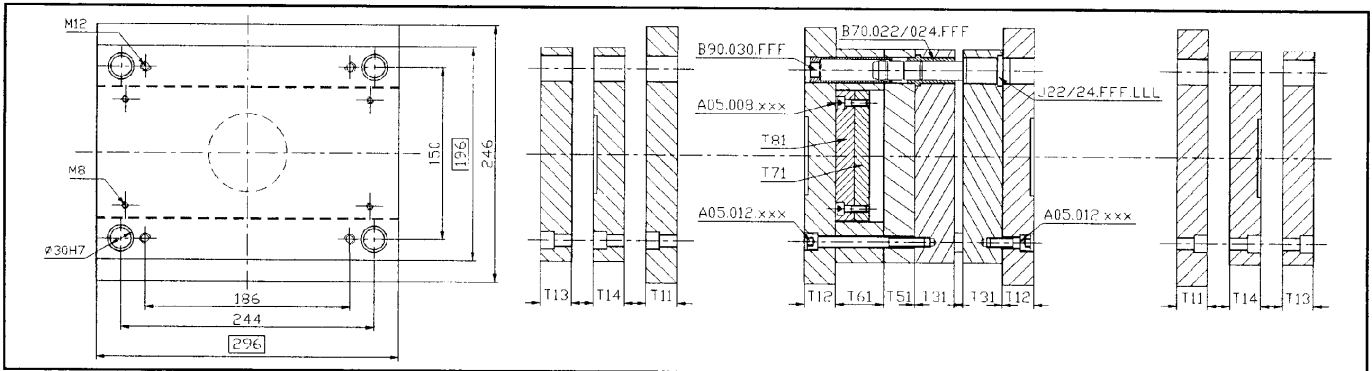

M	A	B	C	D	E
E	1730	2312	2311	2767	2162
27					
36					

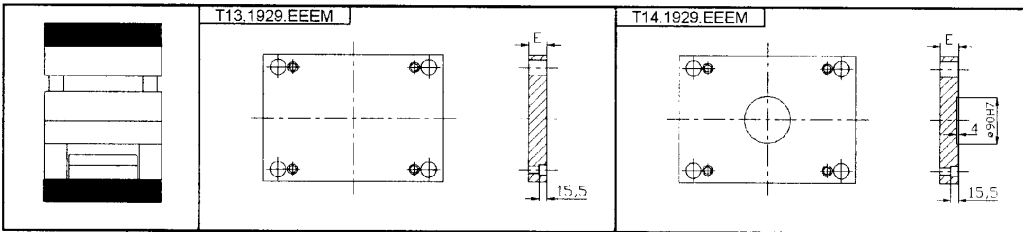

M	A	B	C	D	E
E	1730	2312	2311	2767	2162
22					
27					

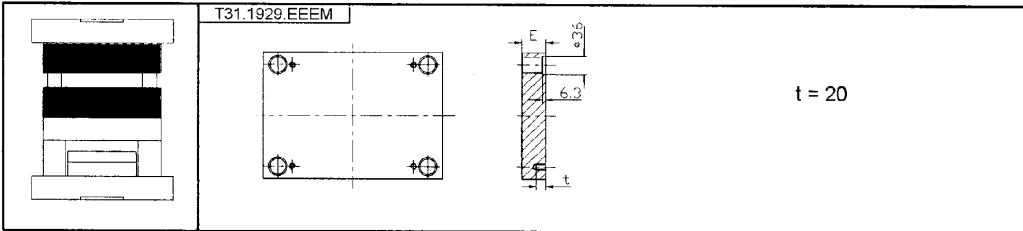

M	A	B	C	D	E
E	1730	2312	2311	2767	2162
27					
36					
46					
56					
66					
76					
86					
96					

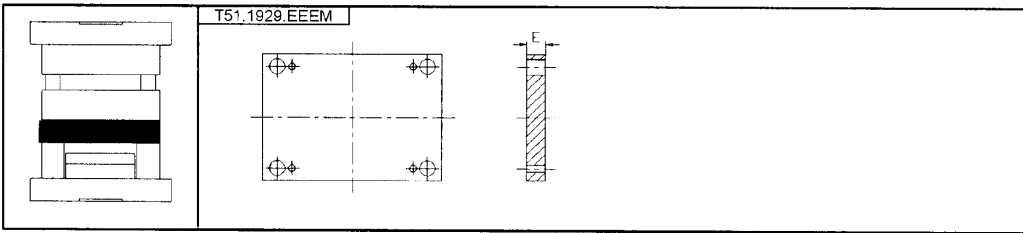

M	A	B	C	D	E
E	1730	2312	2311	2767	2162
36					

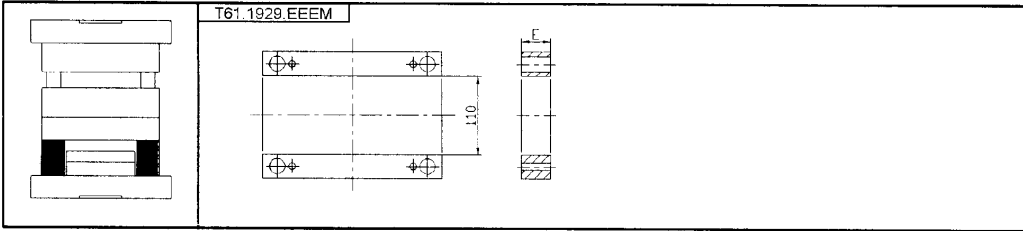

M	A	B	C	D	E
E	1730	2312	2311	2767	2162
56					
76					
96					

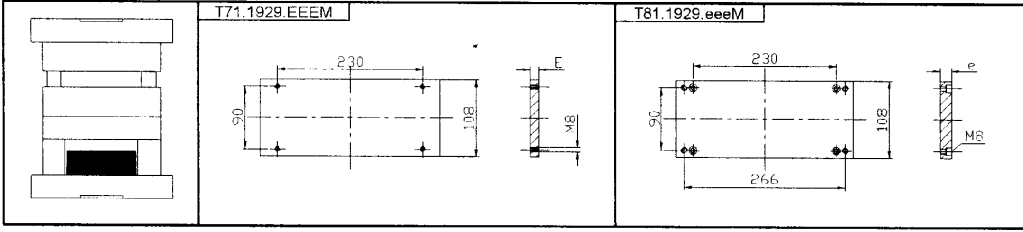

M	A	B	C	D	E
E	1730	2312	2311	2767	2162
12					

  

e	M	A	B	C	D	E
17						

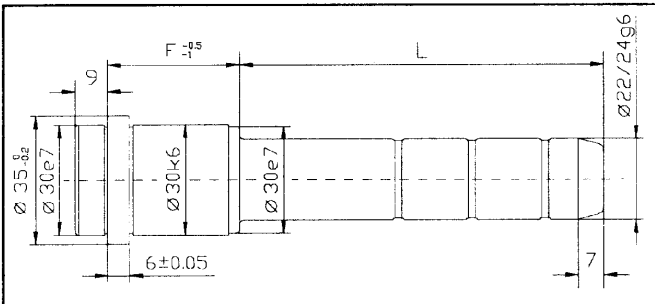
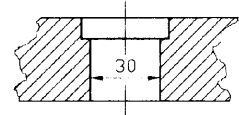

J.22.FFF.LLL / J.24.FFF.LLL

F	L	Nr ∅ / ∅	F	L	Nr ∅ / ∅
27	45	J 22 / 24 .027.045	66	55	J 22 / 24 .066.055
	65	J 22 / 24 .027.065		75	J 22 / 24 .066.075
	105	J 22 / 24 .027.105		95	J 22 / 24 .066.095
36	55	J 22 / 24 .036.055	76	135	J 22 / 24 .066.135
	75	J 22 / 24 .036.075		155	J 22 / 24 .066.155
	105	J 22 / 24 .036.105		195	J 22 / 24 .066.195
	135	J 22 / 24 .036.135		55	J 22 / 24 .076.055
46	165	J 22 / 24 .036.165	86	75	J 22 / 24 .076.075
	65	J 22 / 24 .046.065		95	J 22 / 24 .076.095
	85	J 22 / 24 .046.085		115	J 22 / 24 .076.115
	105	J 22 / 24 .046.105		145	J 22 / 24 .076.145
	125	J 22 / 24 .046.125		195	J 22 / 24 .076.195
56	165	J 22 / 24 .046.165	96	75	J 22 / 24 .086.075
	205	J 22 / 24 .046.205		95	J 22 / 24 .086.095
	55	J 22 / 24 .056.055		135	J 22 / 24 .086.135
	75	J 22 / 24 .056.075		116	75 J 22 / 24 .116.075
	95	J 22 / 24 .056.095		115	J 22 / 24 .116.115
	115	J 22 / 24 .056.115		136	95 J 22 / 24 .136.095
	165	J 22 / 24 .056.165			
	205	J 22 / 24 .056.205		135	J 22 / 24 .136.135

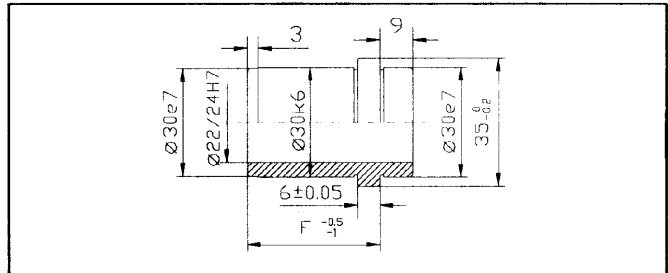

B70.022.OFF / B70.024.OFF

F	Nr ∅ / ∅	F	Nr ∅ / ∅
27	B70.022/24.027	76	B70.022/24.076
36	B70.022/24.036	86	B70.022/24.086
46	B70.022/24.046	96	B70.022/24.096
56	B70.022/24.056	116	B70.022/24.116
66	B70.022/24.066	136	B70.022/24.136

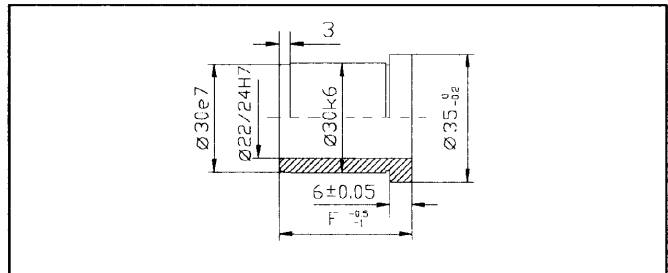

B80.022.OFF / B80.024.OFF

F	Nr ∅ / ∅	F	Nr ∅ / ∅
27	B80.022/24.027	76	B80.022/24.076
36	B80.022/24.036	86	B80.022/24.086
46	B80.022/24.046	96	B80.022/24.096
56	B80.022/24.056	116	B80.022/24.116
66	B80.022/24.066	136	B80.022/24.136

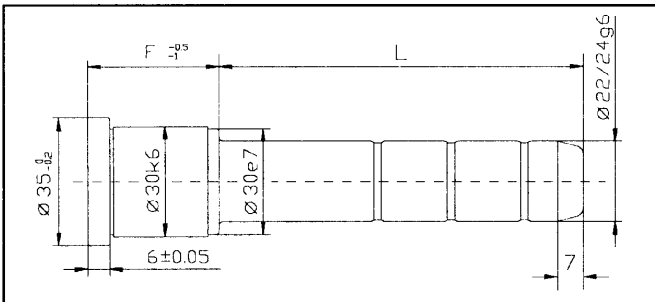

K22.FFF.LLL / K24.FFF.LLL

F	L	Nr ∅ / ∅	F	L	Nr ∅ / ∅
27	45	K 22 / 24 .027.045	66	55	K 22 / 24 .066.055
	65	K 22 / 24 .027.065		75	K 22 / 24 .066.075
	105	K 22 / 24 .027.105		95	K 22 / 24 .066.095
36	55	K 22 / 24 .036.055	76	135	K 22 / 24 .066.135
	75	K 22 / 24 .036.075			
	105	K 22 / 24 .036.105			
	135	K 22 / 24 .036.135			
46	165	K 22 / 24 .036.165	86	55	K 22 / 24 .076.055
	65	K 22 / 24 .046.065		75	K 22 / 24 .076.075
	85	K 22 / 24 .046.085		95	K 22 / 24 .076.095
	105	K 22 / 24 .046.105		115	K 22 / 24 .076.115
	125	K 22 / 24 .046.125			
56			96	75	K 22 / 24 .086.075
	55	K 22 / 24 .056.055		95	K 22 / 24 .086.095
	75	K 22 / 24 .056.075		135	K 22 / 24 .086.135
	95	K 22 / 24 .056.095		96	75 K 22 / 24 .096.075
	115	K 22 / 24 .056.115		95	K 22 / 24 .096.095
				116	75 K 22 / 24 .116.075
		115	K 22 / 24 .116.115		
		136	135 K 22 / 24 .136.135		

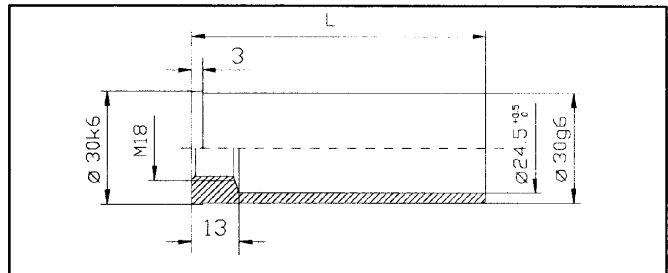

B90.030.LLL

F	Nr	L	Nr
60	B90.030.060	140	B90.030.140
80	B90.030.080	160	B90.030.160
100	B90.030.100	180	B90.030.180
120	B90.030.120		

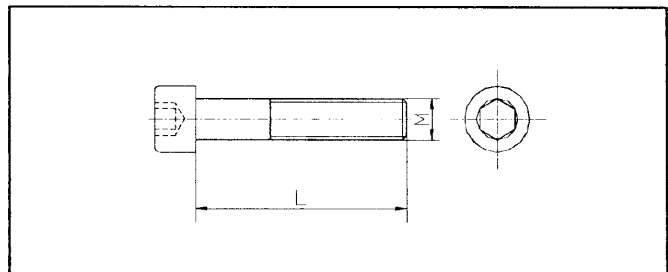

A05.xxx.xxx

M x L	Nr	M x L	Nr	M x L	Nr
8x16	A05.008.016	12x25	A05.012.025	12x90	A05.012.090
		12x30	A05.012.030	12x100	A05.012.100
		12x35	A05.012.035	12x120	A05.012.120
		12x45	A05.012.045	12x130	A05.012.130
		12x50	A05.012.050	12x140	A05.012.140
		12x55	A05.012.055	12x150	A05.012.150
		12x60	A05.012.060	12x160	A05.012.160
		12x65	A05.012.065	12x180	A05.012.180
		12x70	A05.012.070	12x200	A05.012.200
		12x80	A05.012.080		

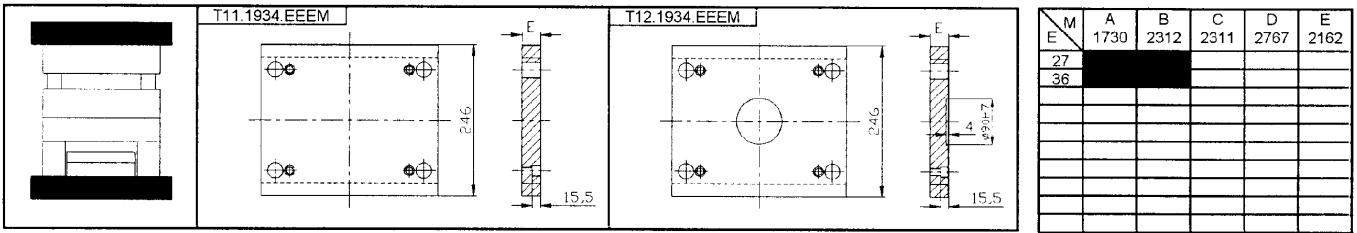
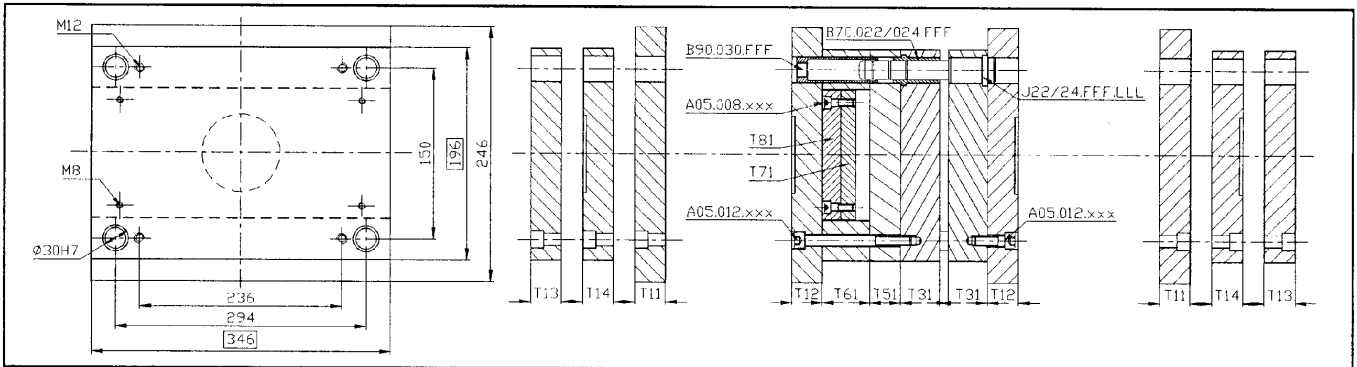

M	A	B	C	D	E
E	1730	2312	2311	2767	2162
27					
36					

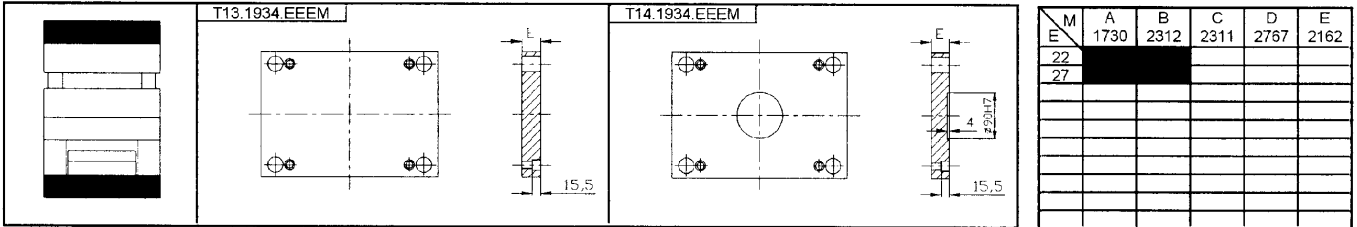

M	A	B	C	D	E
E	1730	2312	2311	2767	2162
22					
27					

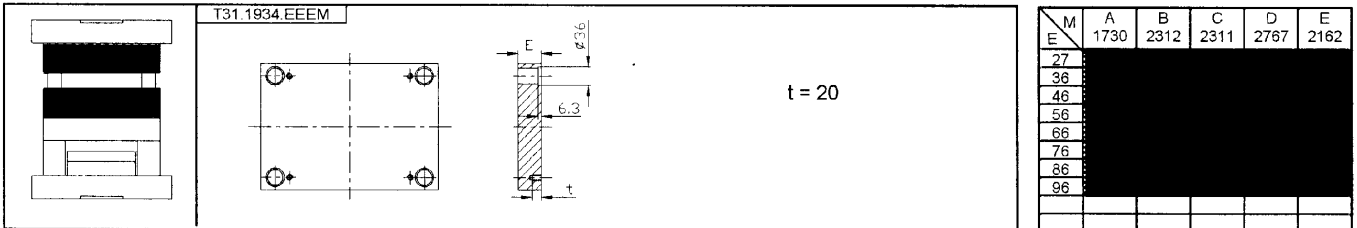

M	A	B	C	D	E
E	1730	2312	2311	2767	2162
27					
36					
46					
56					
66					
76					
86					
96					

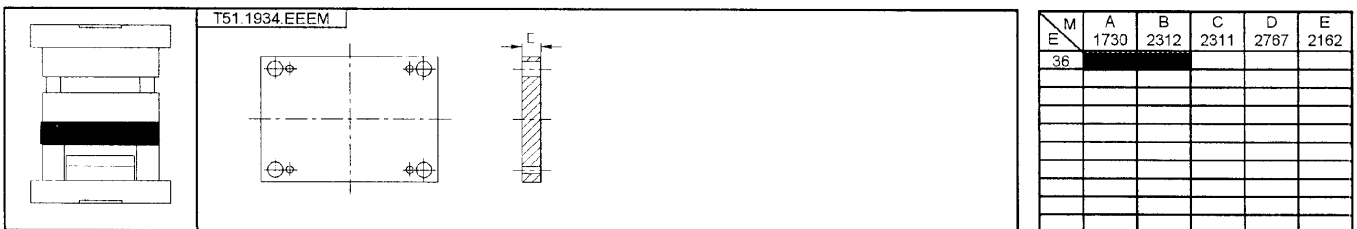

M	A	B	C	D	E
E	1730	2312	2311	2767	2162
36					

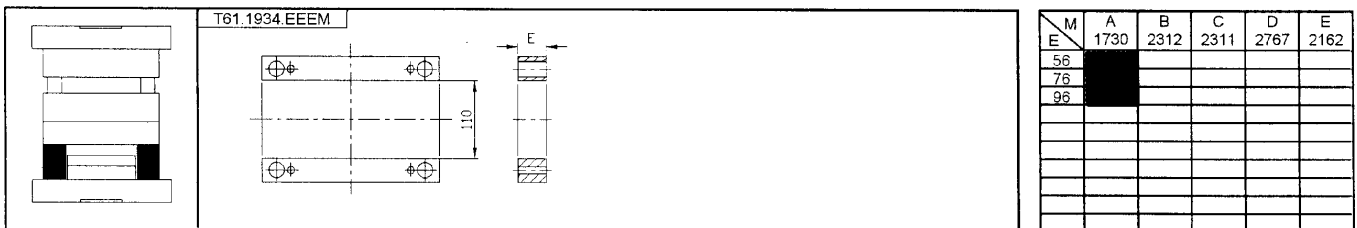

M	A	B	C	D	E
E	1730	2312	2311	2767	2162
56					
76					
96					

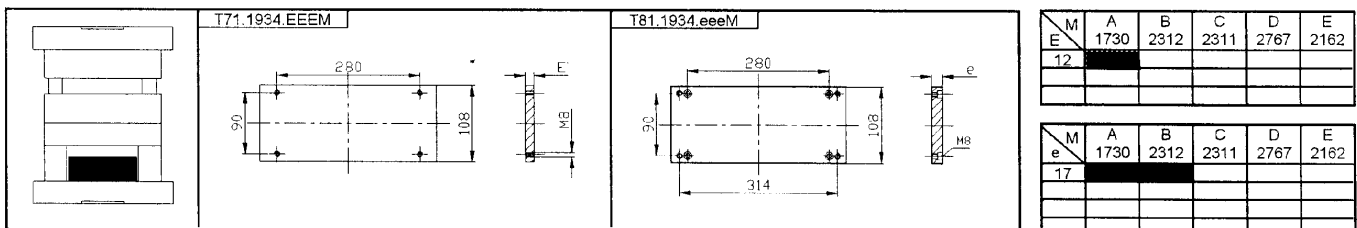

M	A	B	C	D	E
E	1730	2312	2311	2767	2162
12					





Ø 22 / Ø 24

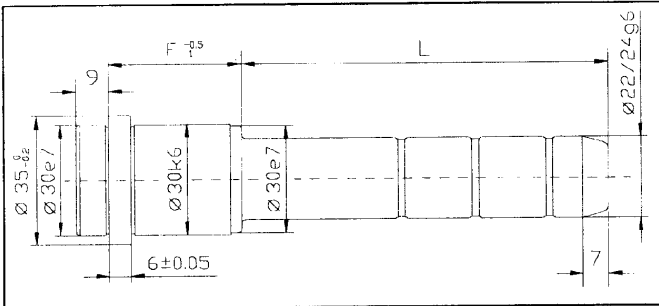
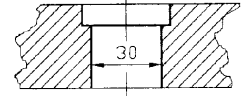

J.22.FFF.LLL / J.24.FFF.LLL					
F	L	Nr ø / Ø	F	L	Nr ø / Ø
27	45	J 22 / 24 .027.045	66	55	J 22 / 24 .066.055
	65	J 22 / 24 .027.065		75	J 22 / 24 .066.075
	105	J 22 / 24 .027.105		95	J 22 / 24 .066.095
36	55	J 22 / 24 .036.055	76	135	J 22 / 24 .066.135
	75	J 22 / 24 .036.075		155	J 22 / 24 .066.155
	105	J 22 / 24 .036.105		195	J 22 / 24 .066.195
	135	J 22 / 24 .036.135		55	J 22 / 24 .076.055
	165	J 22 / 24 .036.165		75	J 22 / 24 .076.075
46	65	J 22 / 24 .046.065	86	95	J 22 / 24 .076.095
	85	J 22 / 24 .046.085		115	J 22 / 24 .076.115
	105	J 22 / 24 .046.105		145	J 22 / 24 .076.145
	125	J 22 / 24 .046.125		195	J 22 / 24 .076.195
	165	J 22 / 24 .046.165		75	J 22 / 24 .086.075
56	205	J 22 / 24 .046.205	96	95	J 22 / 24 .086.095
	55	J 22 / 24 .056.055		135	J 22 / 24 .086.135
	75	J 22 / 24 .056.075		75	J 22 / 24 .096.075
	95	J 22 / 24 .056.095		95	J 22 / 24 .096.095
	115	J 22 / 24 .056.115		116	75
			115	J 22 / 24 .116.115	
			136	95	J 22 / 24 .136.095
				135	J 22 / 24 .136.135

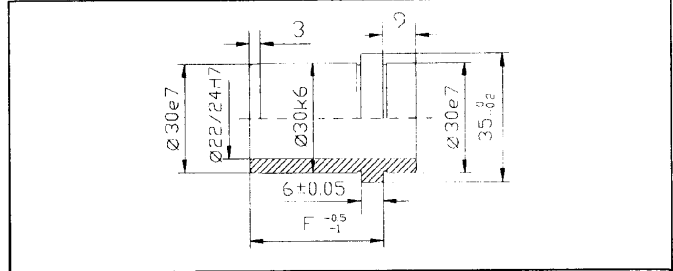

B70.022.OFF / B70.024.OFF			
F	Nr ø / Ø	F	Nr ø / Ø
27	B70.0 22 / 24 .027	76	B70.0 22 / 24 .076
36	B70.0 22 / 24 .036	86	B70.0 22 / 24 .086
46	B70.0 22 / 24 .046	96	B70.0 22 / 24 .096
56	B70.0 22 / 24 .056	116	B70.0 22 / 24 .116
66	B70.0 22 / 24 .066	136	B70.0 22 / 24 .136

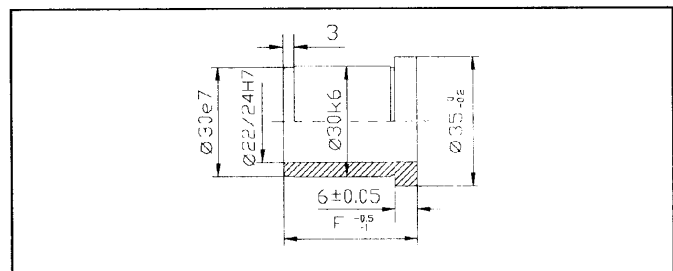

B80.022.OFF / B80.024.OFF			
F	Nr ø / Ø	F	Nr ø / Ø
27	B80.0 22 / 24 .027	76	B80.0 22 / 24 .076
36	B80.0 22 / 24 .036	86	B80.0 22 / 24 .086
46	B80.0 22 / 24 .046	96	B80.0 22 / 24 .096
56	B80.0 22 / 24 .056	116	B80.0 22 / 24 .116
66	B80.0 22 / 24 .066	136	B80.0 22 / 24 .136

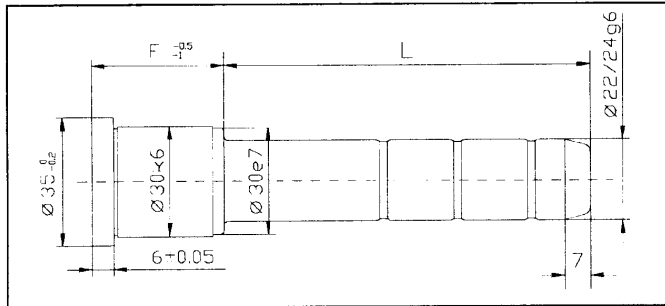

K.22.FFF.LLL / K.24.FFF.LLL						
F	L	Nr ø / Ø	F	L	Nr ø / Ø	
27	45	K 22 / 24 .027.045	66	55	K 22 / 24 .066.055	
	65	K 22 / 24 .027.065		75	K 22 / 24 .066.075	
	105	K 22 / 24 .027.105		95	K 22 / 24 .066.095	
36	55	K 22 / 24 .036.055	76	135	K 22 / 24 .066.135	
	75	K 22 / 24 .036.075				
	105	K 22 / 24 .036.105				
46	135	K 22 / 24 .036.135	86	55	K 22 / 24 .076.055	
				75	K 22 / 24 .076.075	
				95	K 22 / 24 .076.095	
				115	K 22 / 24 .076.115	
56	65	K 22 / 24 .046.065	96	75	K 22 / 24 .086.075	
	85	K 22 / 24 .046.085		95	K 22 / 24 .086.095	
	105	K 22 / 24 .046.105		135	K 22 / 24 .086.135	
	125	K 22 / 24 .046.125		75	K 22 / 24 .096.075	
56			116	95	K 22 / 24 .096.095	
	55	K 22 / 24 .056.055		116	75	K 22 / 24 .116.075
	75	K 22 / 24 .056.075		115	115	K 22 / 24 .116.115
	95	K 22 / 24 .056.095		136	135	K 22 / 24 .136.135

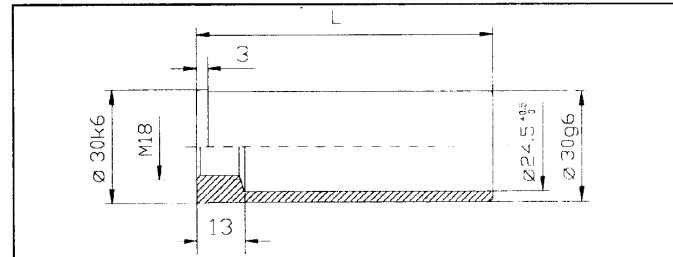

B90.030.LLL			
F	Nr	L	Nr
60	B90.030.060	140	B90.030.140
80	B90.030.080	160	B90.030.160
100	B90.030.100	180	B90.030.180
120	B90.030.120		

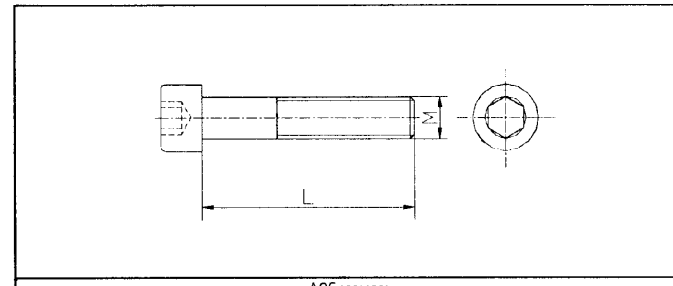

A05.xxx.xxx					
M x L	Nr	M x L	Nr	M x L	Nr
8x16	A05.008.016	12x25	A05.012.025	12x90	A05.012.090
		12x30	A05.012.030	12x100	A05.012.100
		12x35	A05.012.035	12x120	A05.012.120
		12x45	A05.012.045	12x130	A05.012.130
		12x50	A05.012.050	12x140	A05.012.140
		12x55	A05.012.055	12x150	A05.012.150
		12x60	A05.012.060	12x160	A05.012.160
		12x65	A05.012.065	12x180	A05.012.180
		12x70	A05.012.070	12x200	A05.012.200
		12x80	A05.012.080		

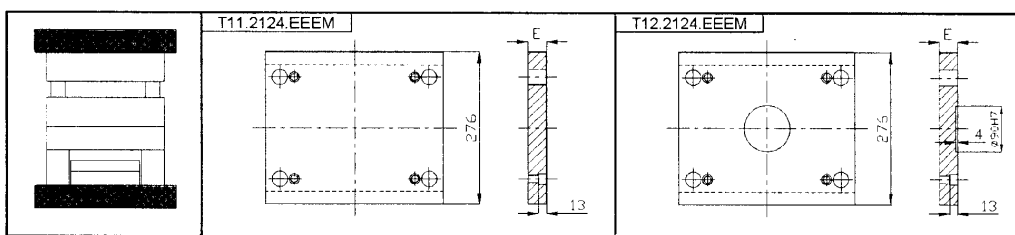
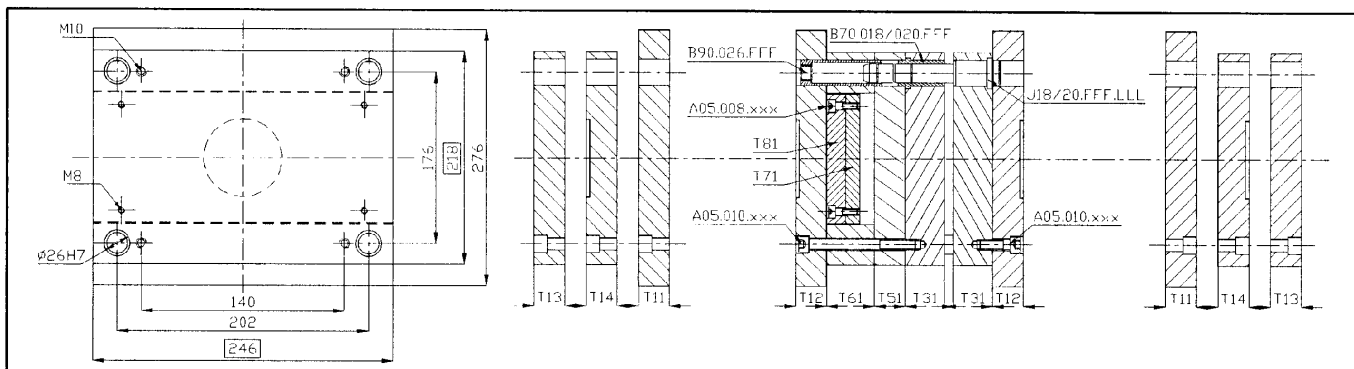

E \ M	A 1730	B 2312	C 2311	D 2767	E 2162
22					
27					

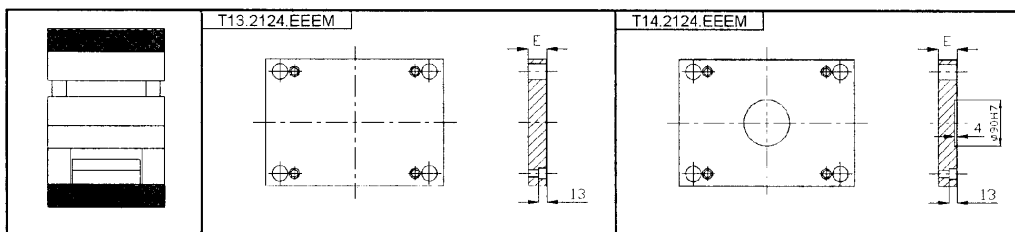

E \ M	A 1730	B 2312	C 2311	D 2767	E 2162
17					
22					

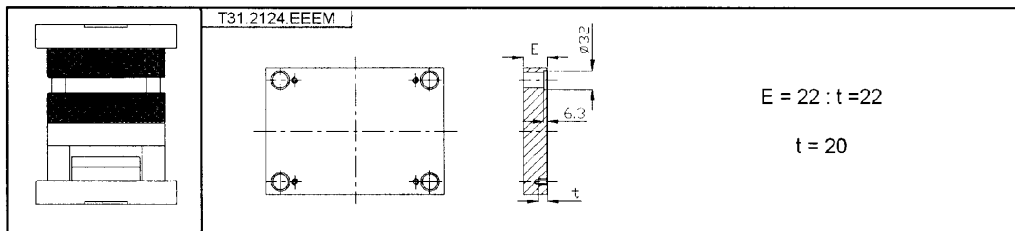

E \ M	A 1730	B 2312	C 2311	D 2767	E 2162
22					
27					
36					
46					
56					
66					
76					
86					
96					

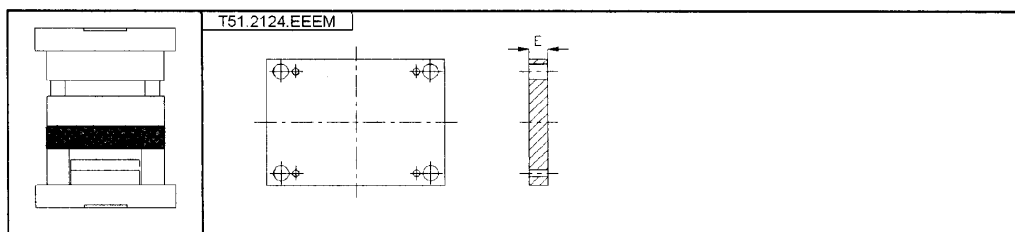

E \ M	A 1730	B 2312	C 2311	D 2767	E 2162
27					
36					

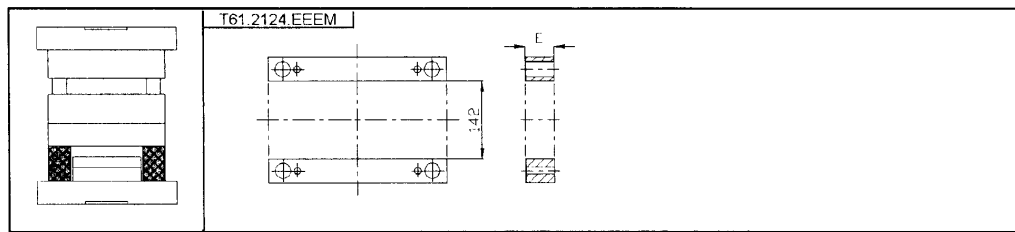

E \ M	A 1730	B 2312	C 2311	D 2767	E 2162
46					
56					
76					

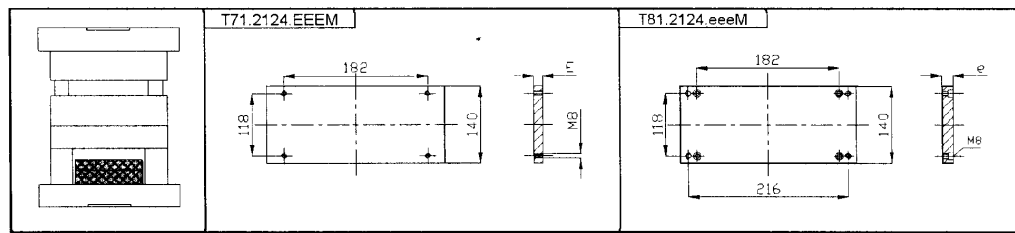

E \ M	A 1730	B 2312	C 2311	D 2767	E 2162
12					

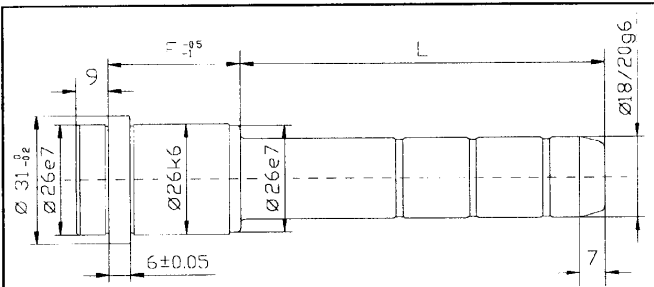
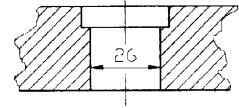

J18.FFF.LLL / J20.FFF.LLL					
F	L	Nr ø/Ø	F	L	Nr ø/Ø
22	35	J 18 / 20 .022.035	56	55	J 18 / 20 .056.055
	45	J 18 / 20 .022.045		75	J 18 / 20 .056.075
	85	J 18 / 20 .022.085		95	J 18 / 20 .056.095
27	35	J 18 / 20 .027.035	66	155	J 18 / 20 .056.135
	45	J 18 / 20 .027.045		55	J 18 / 20 .066.055
	65	J 18 / 20 .027.065		75	J 18 / 20 .066.075
	105	J 18 / 20 .027.105		95	J 18 / 20 .066.095
	125	J 18 / 20 .027.125		145	J 18 / 20 .066.145
36	165	J 18 / 20 .027.165	76	55	J 18 / 20 .076.055
	35	J 18 / 20 .036.035		75	J 18 / 20 .076.075
	55	J 18 / 20 .036.055		95	J 18 / 20 .076.095
	75	J 18 / 20 .036.075		135	J 18 / 20 .076.135
	115	J 18 / 20 .036.115		75	J 18 / 20 .086.075
46	135	J 18 / 20 .036.135	86	95	J 18 / 20 .086.095
	165	J 18 / 20 .036.165		125	J 18 / 20 .086.125
	35	J 18 / 20 .046.035		75	J 18 / 20 .096.075
	45	J 18 / 20 .046.045		95	J 18 / 20 .096.095
	65	J 18 / 20 .046.065		135	J 18 / 20 .096.135
	105	J 18 / 20 .046.105			
	135	J 18 / 20 .046.135			
	165	J 18 / 20 .046.165			

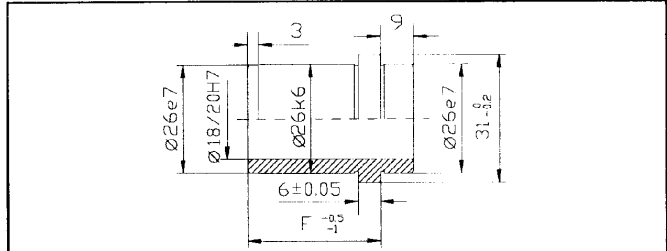

B70.018.OFF / B70.020.OFF			
F	Nr ø/Ø	F	Nr ø/Ø
22	B70.0 18 / 20 .022	66	B70.0 18 / 20 .066
27	B70.0 18 / 20 .027	76	B70.0 18 / 20 .076
36	B70.0 18 / 20 .036	86	B70.0 18 / 20 .086
46	B70.0 18 / 20 .046	96	B70.0 18 / 20 .096
56	B70.0 18 / 20 .056		

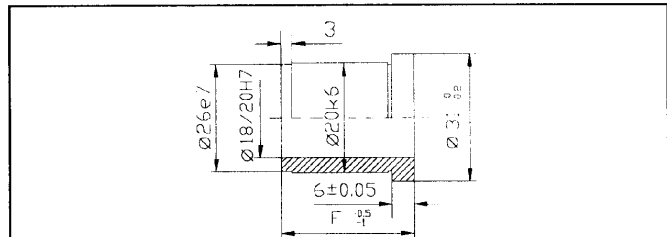

B80.018.OFF / B80.020.OFF			
F	Nr ø/Ø	F	Nr ø/Ø
22	B80.0 18 / 20 .022	66	B80.0 18 / 20 .066
27	B80.0 18 / 20 .027	76	B80.0 18 / 20 .076
36	B80.0 18 / 20 .036	86	B80.0 18 / 20 .086
46	B80.0 18 / 20 .046	96	B80.0 18 / 20 .096
56	B80.0 18 / 20 .056		

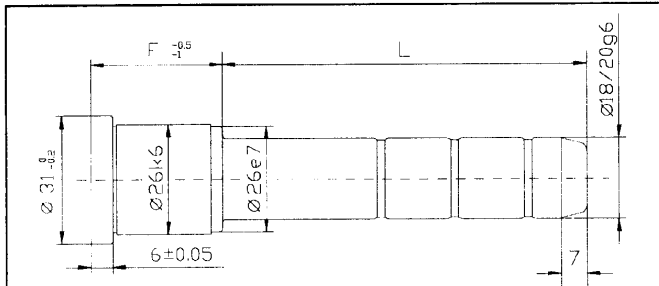

K18.FFF.LLL / K20.FFF.LLL					
F	L	Nr ø/Ø	F	L	Nr ø/Ø
22	35	K 18 / 20.022.035	56	55	K 18 / 20 .056.055
	55	K 18 / 20 .022.055		75	K 18 / 20 .056.075
	85	K 18 / 20 .022.085		95	K 18 / 20 .056.095
27	35	K 18 / 20 .027.035	66		
	45	K 18 / 20 .027.045		55	K 18 / 20 .066.055
	65	K 18 / 20 .027.065		75	K 18 / 20 .066.075
	105	K 18 / 20 .027.105		95	K 18 / 20 .066.095
	125	K 18 / 20 .027.125			
36			76	55	K 18 / 20 .076.055
	35	K 18 / 20 .036.035		75	K 18 / 20 .076.075
	55	K 18 / 20 .036.055		95	K 18 / 20 .076.095
	75	K 18 / 20 .036.075			
	115	K 18 / 20 .036.115		75	K 18 / 20 .086.075
46	135	K 18 / 20 .036.135	86	95	K 18 / 20 .086.095
	45	K 18 / 20 .046.045		75	K 18 / 20 .096.075
	65	K 18 / 20 .046.065		95	K 18 / 20 .096.095
	85	K 18 / 20 .046.085			
	105	K 18 / 20 .046.105			
	135	K 18 / 20 .046.135			

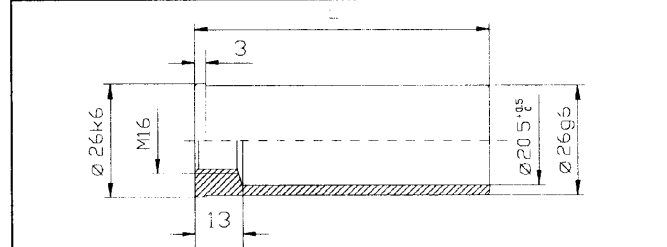

B90.026.LLL			
L	Nr	L	Nr
40	B90.026.040	100	B90.026.100
60	B90.026.060	120	B90.026.120
80	B90.026.080	140	B90.026.140

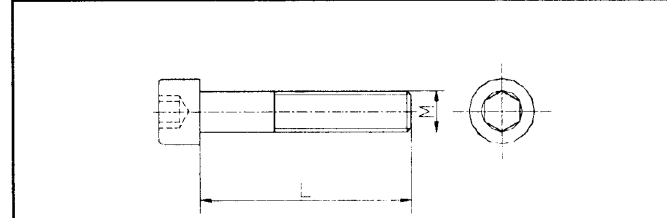

A05.xxx.xxx					
M x L	Nr	M x L	Nr	M x L	Nr
8x16	A05.008.016	10x35	A05.010.035	10x90	A05.010.090
		10x40	A05.010.040	10x100	A05.010.100
		10x45	A05.010.045	10x120	A05.010.120
		10x50	A05.010.050	10x130	A05.010.130
		10x55	A05.010.055	10x140	A05.010.140
10x20	A05.010.020	10x60	A05.010.060	10x150	A05.010.150
		10x65	A05.010.065	10x160	A05.010.160
		10x70	A05.010.070	10x180	A05.010.180
		10x75	A05.010.075	10x200	A05.010.200
		10x80	A05.010.080		

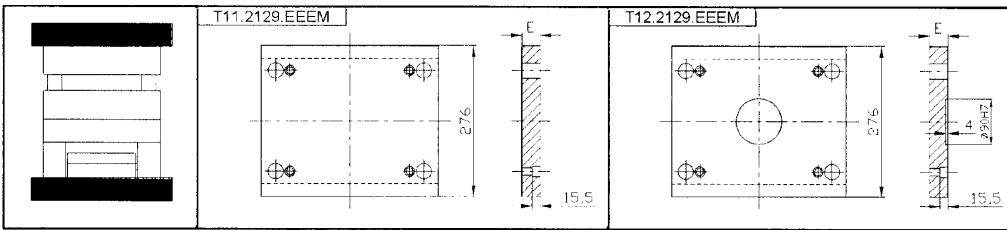
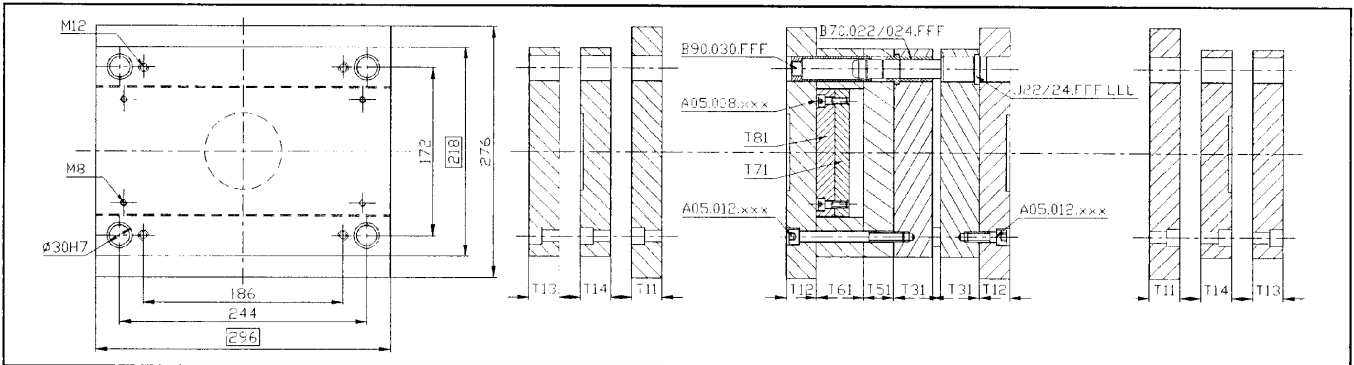

M	A	B	C	D	E
E	1730	2312	2311	2767	2162
27					
36					

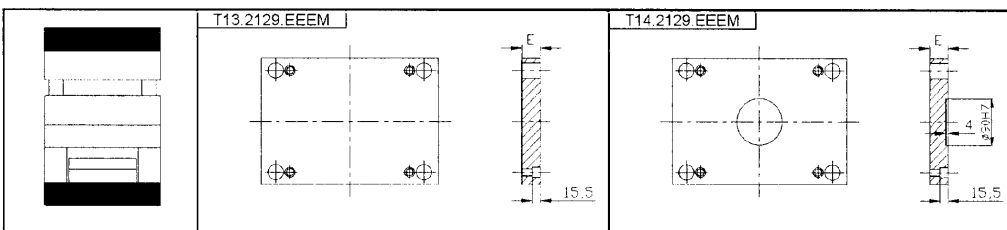

M	A	B	C	D	E
E	1730	2312	2311	2767	2162
22					
27					

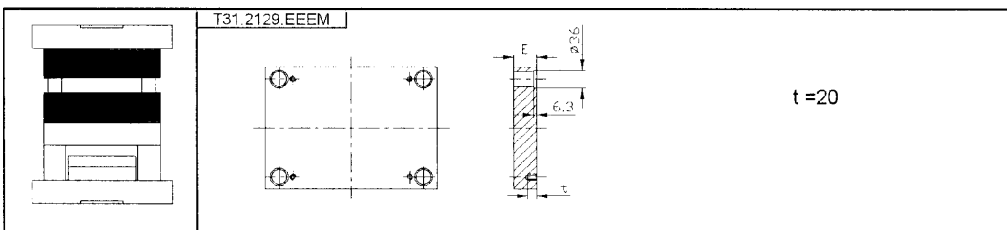

M	A	B	C	D	E
E	1730	2312	2311	2767	2162
27					
36					
46					
56					
66					
76					
86					
96					

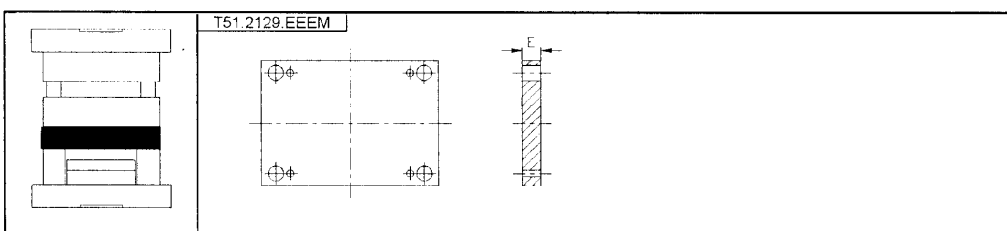

M	A	B	C	D	E
E	1730	2312	2311	2767	2162
27					
36					

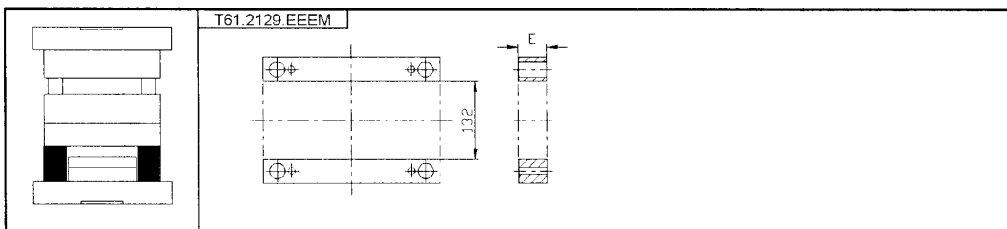

M	A	B	C	D	E
E	1730	2312	2311	2767	2162
56					
76					
96					

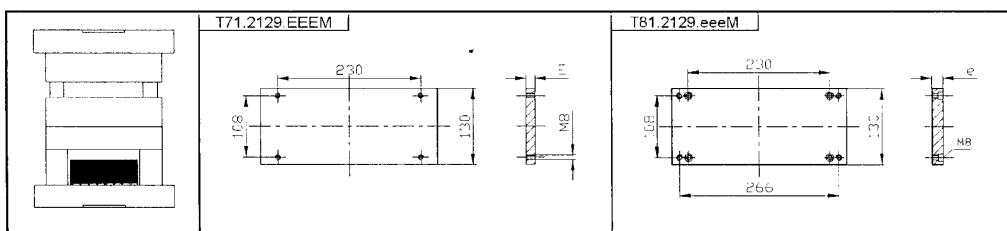

M	A	B	C	D	E
E	1730	2312	2311	2767	2162
12					

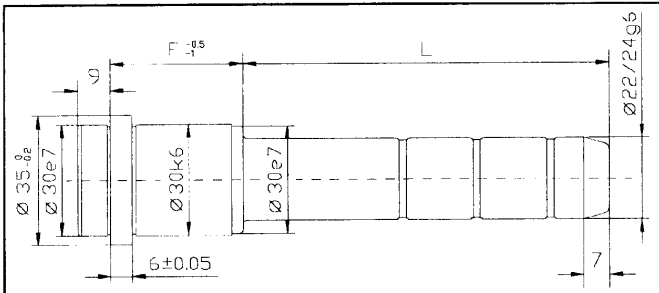
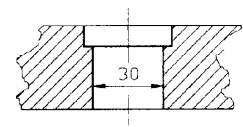

J.22.FFF.LLL / J.24.FFF.LLL					
F	L	Nr ∅ / ∅	F	L	Nr ∅ / ∅
27	45	J 22 / 24 .027.045	66	55	J 22 / 24 .066.055
	65	J 22 / 24 .027.065		75	J 22 / 24 .066.075
	105	J 22 / 24 .027.105		95	J 22 / 24 .066.095
36	55	J 22 / 24 .036.055	76	135	J 22 / 24 .076.135
	75	J 22 / 24 .036.075		155	J 22 / 24 .076.155
	105	J 22 / 24 .036.105		195	J 22 / 24 .076.195
	135	J 22 / 24 .036.135		55	J 22 / 24 .076.055
	165	J 22 / 24 .036.165		75	J 22 / 24 .076.075
46	65	J 22 / 24 .046.065	86	95	J 22 / 24 .086.095
	85	J 22 / 24 .046.085		115	J 22 / 24 .086.115
	105	J 22 / 24 .046.105		145	J 22 / 24 .086.145
	125	J 22 / 24 .046.125		195	J 22 / 24 .086.195
	165	J 22 / 24 .046.165		75	J 22 / 24 .086.075
56	205	J 22 / 24 .056.205	116	95	J 22 / 24 .096.095
	55	J 22 / 24 .056.055		135	J 22 / 24 .096.135
	75	J 22 / 24 .056.075		96	75 J 22 / 24 .096.075
	95	J 22 / 24 .056.095		95	J 22 / 24 .096.095
	115	J 22 / 24 .056.115		116	75 J 22 / 24 .116.075
	165	J 22 / 24 .056.165		115	J 22 / 24 .116.115
	205	J 22 / 24 .056.205	136	95	J 22 / 24 .136.095
				135	J 22 / 24 .136.135

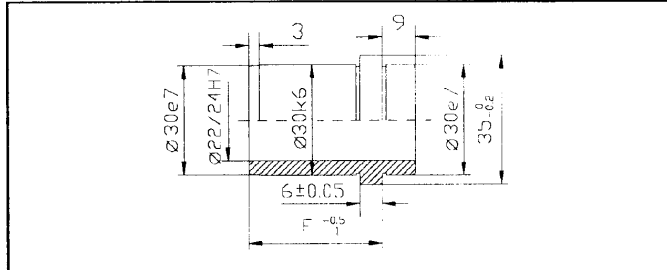

B70.022.OFF / B70.024.OFF			
F	Nr ∅ / ∅	F	Nr ∅ / ∅
27	B70.0 22 / 24 .027	76	B70.0 22 / 24 .076
36	B70.0 22 / 24 .036	86	B70.0 22 / 24 .086
46	B70.0 22 / 24 .046	96	B70.0 22 / 24 .096
56	B70.0 22 / 24 .056	116	B70.0 22 / 24 .116
66	B70.0 22 / 24 .066	136	B70.0 22 / 24 .136

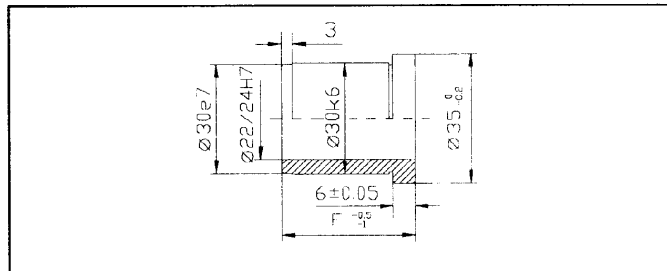

B80.022.OFF / B80.024.OFF			
F	Nr ∅ / ∅	F	Nr ∅ / ∅
27	B80.0 22 / 24 .027	76	B80.0 22 / 24 .076
36	B80.0 22 / 24 .036	86	B80.0 22 / 24 .086
46	B80.0 22 / 24 .046	96	B80.0 22 / 24 .096
56	B80.0 22 / 24 .056	116	B80.0 22 / 24 .116
66	B80.0 22 / 24 .066	136	B80.0 22 / 24 .136

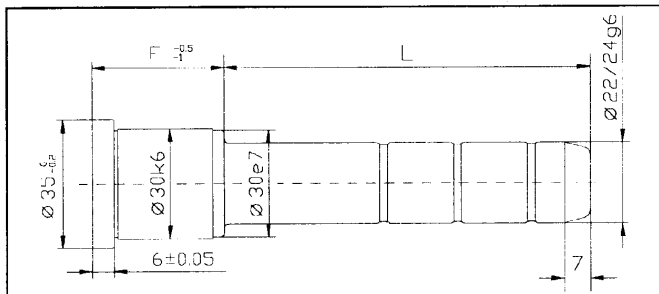

K22.FFF.LLL / K24.FFF.LLL					
F	L	Nr ∅ / ∅	F	L	Nr ∅ / ∅
27	45	K 22 / 24 .027.045	66	55	K 22 / 24 .066.055
	65	K 22 / 24 .027.065		75	K 22 / 24 .066.075
	105	K 22 / 24 .027.105		95	K 22 / 24 .066.095
36	55	K 22 / 24 .036.055	76	135	K 22 / 24 .076.135
	75	K 22 / 24 .036.075		55	K 22 / 24 .076.055
	105	K 22 / 24 .036.105		75	K 22 / 24 .076.075
46	135	K 22 / 24 .036.135	86	95	K 22 / 24 .086.095
	65	K 22 / 24 .046.065		115	K 22 / 24 .076.115
	85	K 22 / 24 .046.085		75	K 22 / 24 .086.075
	105	K 22 / 24 .046.105		95	K 22 / 24 .086.095
56	125	K 22 / 24 .046.125	116	135	K 22 / 24 .086.135
	55	K 22 / 24 .056.055		96	75 K 22 / 24 .096.075
	75	K 22 / 24 .056.075		95	K 22 / 24 .096.095
	95	K 22 / 24 .056.095		116	75 K 22 / 24 .116.075
	115	K 22 / 24 .056.115		115	K 22 / 24 .116.115
			136	135	K 22 / 24 .136.135

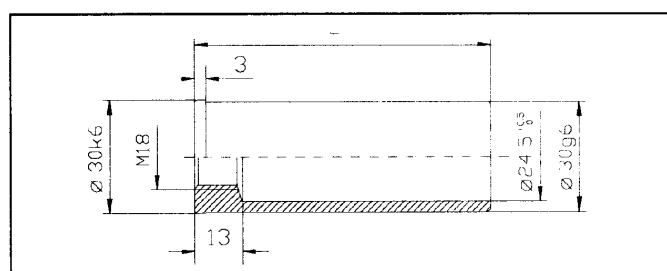

B90.030.LLL			
F	Nr	L	Nr
60	B90.030.060	140	B90.030.140
80	B90.030.080	160	B90.030.160
100	B90.030.100	180	B90.030.180
120	B90.030.120		

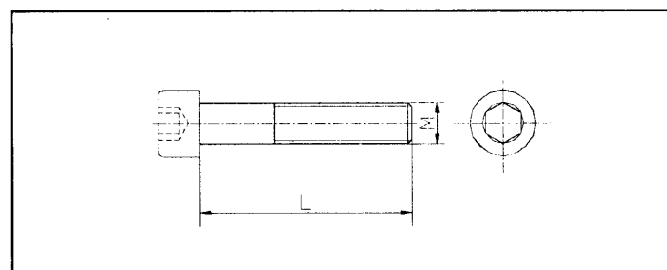

A05.xxx.xxx					
M x L	Nr	M x L	Nr	M x L	Nr
8x16	A05.008.016	12x25	A05.012.025	12x90	A05.012.090
		12x30	A05.012.030	12x100	A05.012.100
		12x35	A05.012.035	12x120	A05.012.120
		12x45	A05.012.045	12x130	A05.012.130
		12x50	A05.012.050	12x140	A05.012.140
		12x55	A05.012.055	12x150	A05.012.150
		12x60	A05.012.060	12x160	A05.012.160
		12x65	A05.012.065	12x180	A05.012.180
		12x70	A05.012.070	12x200	A05.012.200
		12x80	A05.012.080		

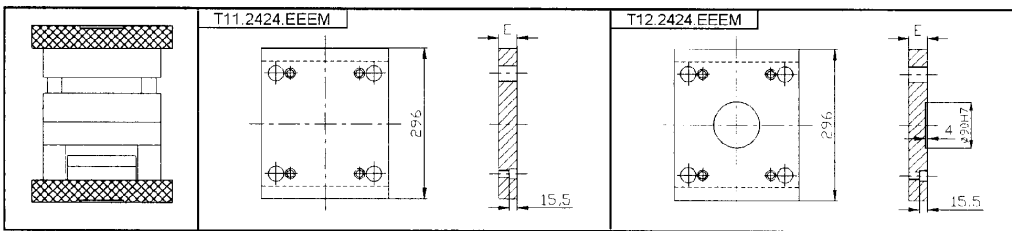
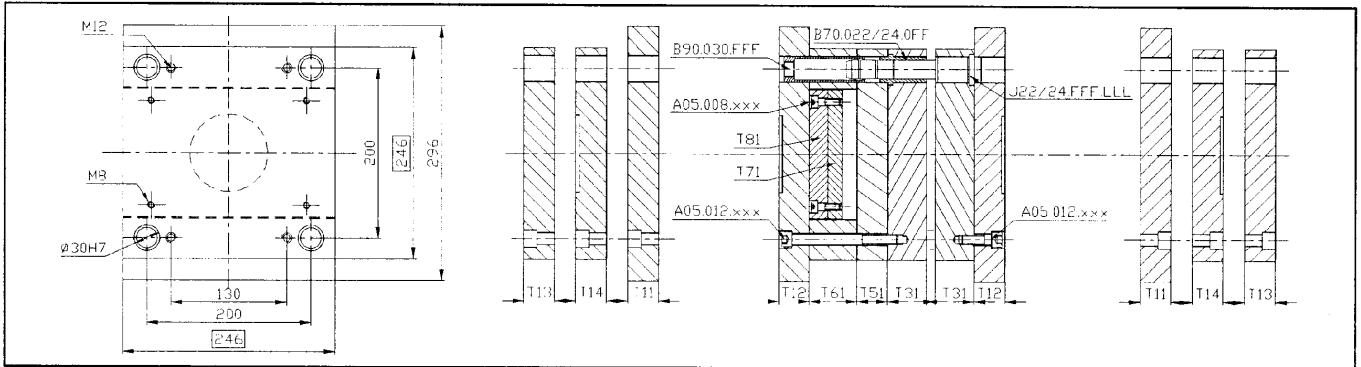

M	A	B	C	D	E
E	1730	2312	2311	2767	2162
27					
36					

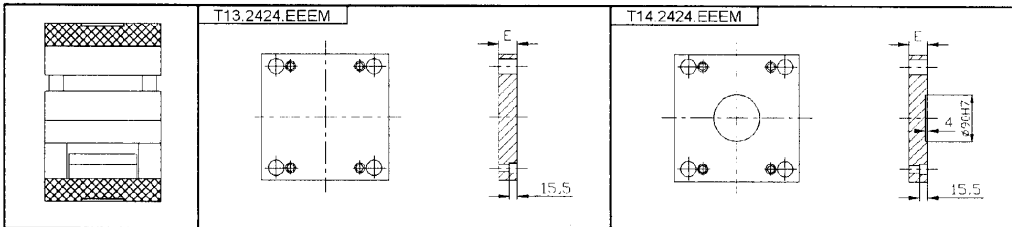

M	A	B	C	D	E
E	1730	2312	2311	2767	2162
22					
27					

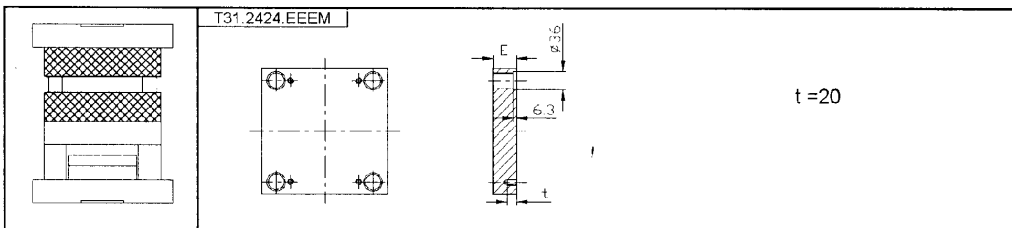

M	A	B	C	D	E
E	1730	2312	2311	2767	2162
27					
36					
46					
56					
66					
76					
86					
96					

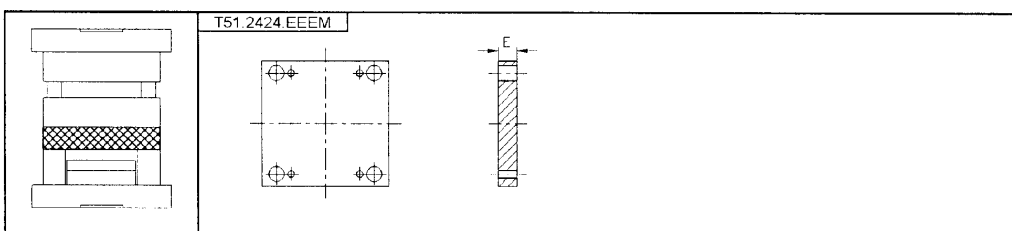

M	A	B	C	D	E
E	1730	2312	2311	2767	2162
36					

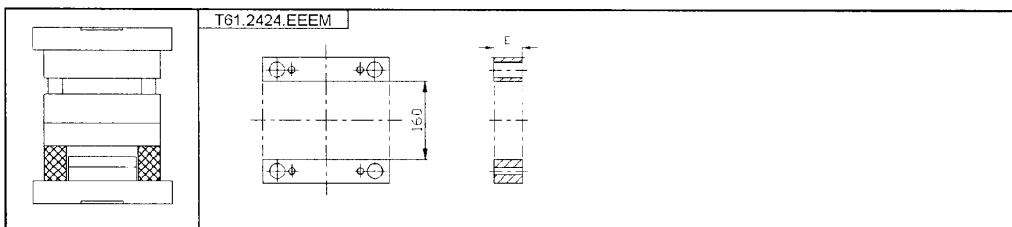

M	A	B	C	D	E
E	1730	2312	2311	2767	2162
56					
76					
96					

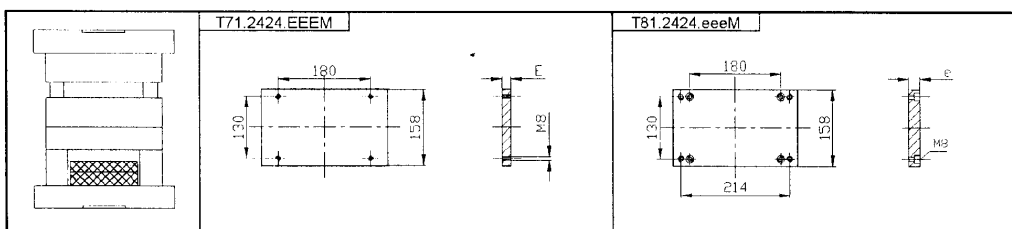

M	A	B	C	D	E
E	1730	2312	2311	2767	2162
12					

  

M	A	B	C	D	E
e	1730	2312	2311	2767	2162
17					



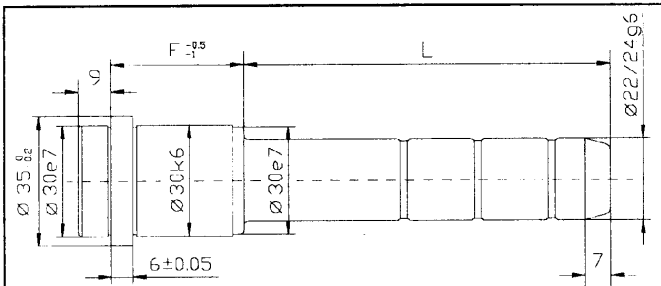
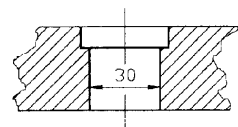

J.22.FFF.LLL / J.24.FFF.LLL					
F	L	Nr ø / Ø	F	L	Nr ø / Ø
27	45	J 22 / 24 .027.045	66	55	J 22 / 24 .066.055
	65	J 22 / 24 .027.065		75	J 22 / 24 .066.075
	105	J 22 / 24 .027.105		95	J 22 / 24 .066.095
36	55	J 22 / 24 .036.055	76	135	J 22 / 24 .076.135
	75	J 22 / 24 .036.075		155	J 22 / 24 .076.155
	105	J 22 / 24 .036.105		195	J 22 / 24 .076.195
	135	J 22 / 24 .036.135		55	J 22 / 24 .076.055
46	165	J 22 / 24 .036.165	86	75	J 22 / 24 .086.075
	65	J 22 / 24 .046.065		95	J 22 / 24 .086.095
	85	J 22 / 24 .046.085		115	J 22 / 24 .086.115
	105	J 22 / 24 .046.105		145	J 22 / 24 .086.145
	125	J 22 / 24 .046.125		195	J 22 / 24 .086.195
56	165	J 22 / 24 .046.165	96	75	J 22 / 24 .096.075
	205	J 22 / 24 .046.205		95	J 22 / 24 .096.095
	55	J 22 / 24 .056.055		116	J 22 / 24 .116.075
	75	J 22 / 24 .056.075		115	J 22 / 24 .116.115
	95	J 22 / 24 .056.095		136	J 22 / 24 .136.095
			135	J 22 / 24 .136.135	

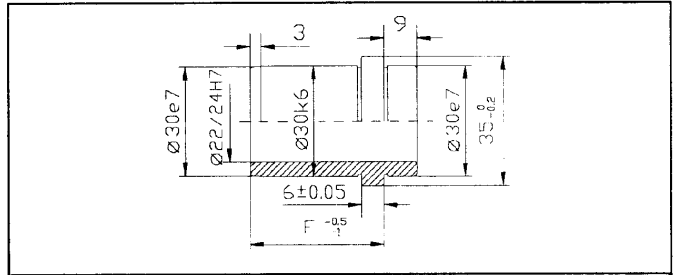

B70.022.OFF / B70.024.OFF			
F	Nr ø / Ø	F	Nr ø / Ø
27	B70.0 22 / 24 .027	76	B70.0 22 / 24 .076
36	B70.0 22 / 24 .036	86	B70.0 22 / 24 .086
46	B70.0 22 / 24 .046	96	B70.0 22 / 24 .096
56	B70.0 22 / 24 .056	116	B70.0 22 / 24 .116
66	B70.0 22 / 24 .066	136	B70.0 22 / 24 .136

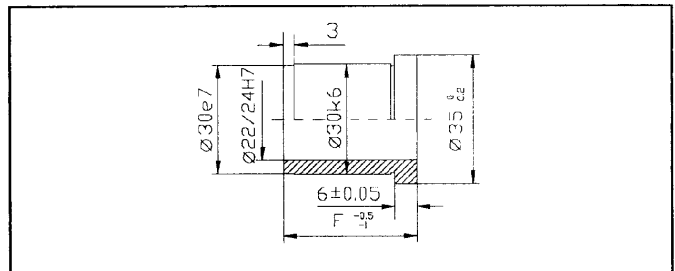

B80.022.OFF / B80.024.OFF			
F	Nr ø / Ø	F	Nr ø / Ø
27	B80.0 22 / 24 .027	76	B80.0 22 / 24 .076
36	B80.0 22 / 24 .036	86	B80.0 22 / 24 .086
46	B80.0 22 / 24 .046	96	B80.0 22 / 24 .096
56	B80.0 22 / 24 .056	116	B80.0 22 / 24 .116
66	B80.0 22 / 24 .066	136	B80.0 22 / 24 .136

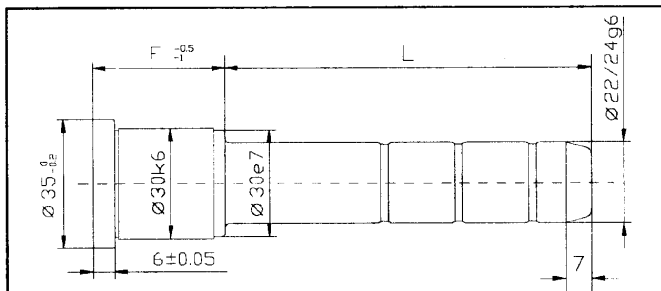

K22.FFF.LLL / K24.FFF.LLL					
F	L	Nr ø / Ø	F	L	Nr ø / Ø
27	45	K 22 / 24 .027.045	66	55	K 22 / 24 .066.055
	65	K 22 / 24 .027.065		75	K 22 / 24 .066.075
	105	K 22 / 24 .027.105		95	K 22 / 24 .066.095
36	55	K 22 / 24 .036.055	76	135	K 22 / 24 .076.135
	75	K 22 / 24 .036.075		155	K 22 / 24 .076.155
	105	K 22 / 24 .036.105		195	K 22 / 24 .076.195
	135	K 22 / 24 .036.135		55	K 22 / 24 .076.055
46	165	K 22 / 24 .036.165	86	75	K 22 / 24 .086.075
	65	K 22 / 24 .046.065		95	K 22 / 24 .086.095
	85	K 22 / 24 .046.085		115	K 22 / 24 .086.115
	105	K 22 / 24 .046.105		135	K 22 / 24 .086.135
	125	K 22 / 24 .046.125		95	K 22 / 24 .086.095
56	165	K 22 / 24 .046.165	96	75	K 22 / 24 .096.075
	205	K 22 / 24 .046.205		95	K 22 / 24 .096.095
	55	K 22 / 24 .056.055		116	K 22 / 24 .116.075
	75	K 22 / 24 .056.075		115	K 22 / 24 .116.115
	95	K 22 / 24 .056.095		136	K 22 / 24 .136.095
			135	K 22 / 24 .136.135	

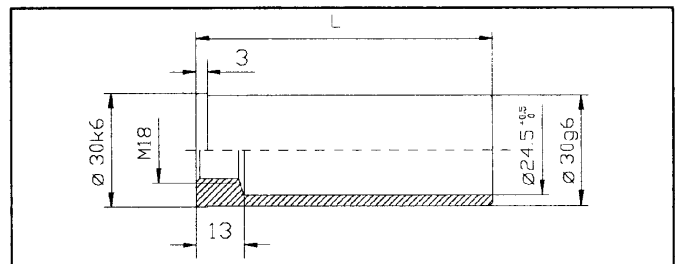

B90.030.LLL			
F	Nr	L	Nr
60	B90.030.060	140	B90.030.140
80	B90.030.080	160	B90.030.160
100	B90.030.100	180	B90.030.180
120	B90.030.120		

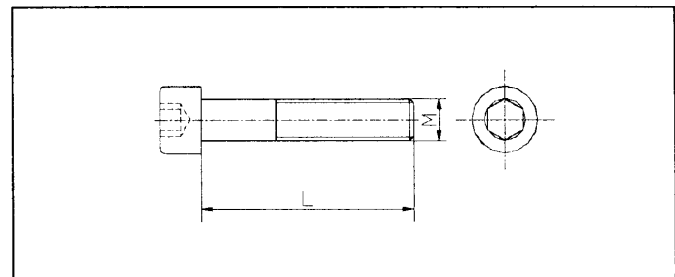

A05.xxx.xxx					
M x L	Nr	M x L	Nr	M x L	Nr
8x16	A05.008.016	12x25	A05.012.025	12x90	A05.012.090
		12x30	A05.012.030	12x100	A05.012.100
		12x35	A05.012.035	12x120	A05.012.120
		12x45	A05.012.045	12x130	A05.012.130
		12x50	A05.012.050	12x140	A05.012.140
		12x55	A05.012.055	12x150	A05.012.150
		12x60	A05.012.060	12x160	A05.012.160
		12x65	A05.012.065	12x180	A05.012.180
		12x70	A05.012.070	12x200	A05.012.200
		12x80	A05.012.080		

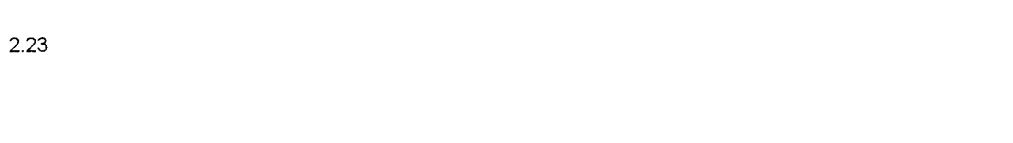
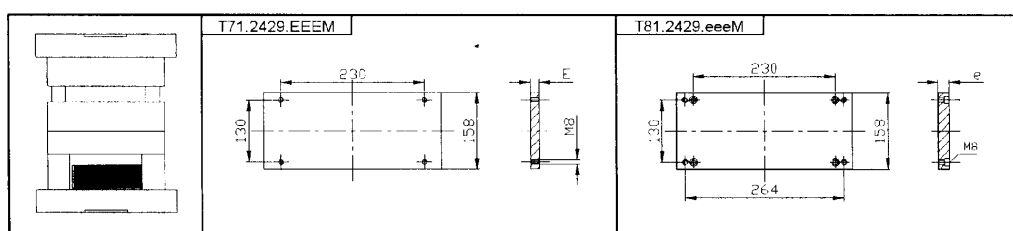
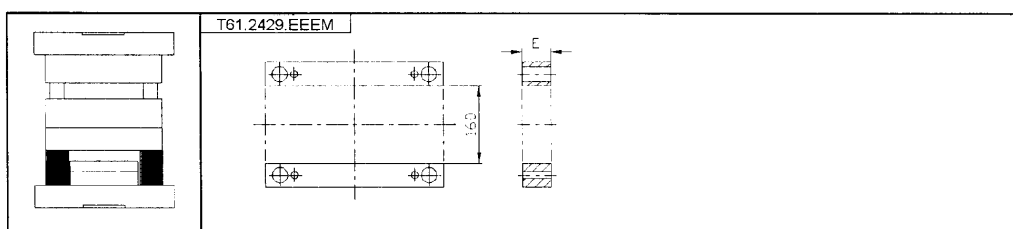
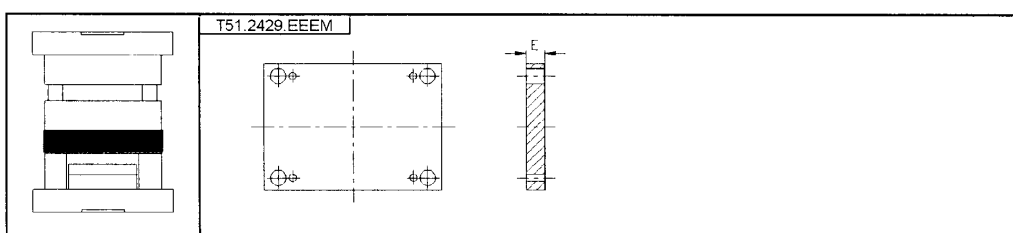
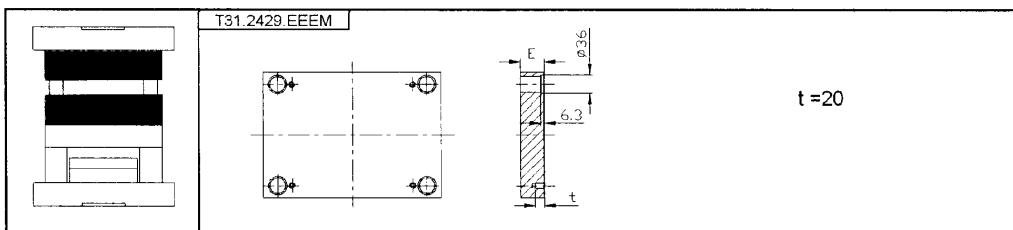
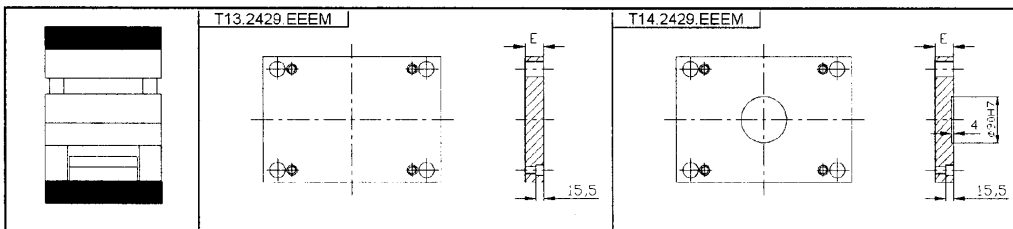
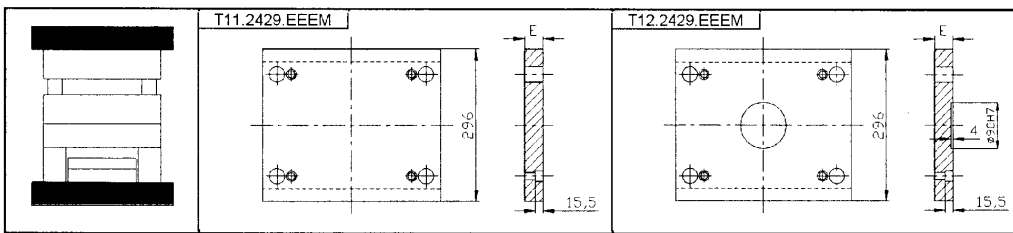
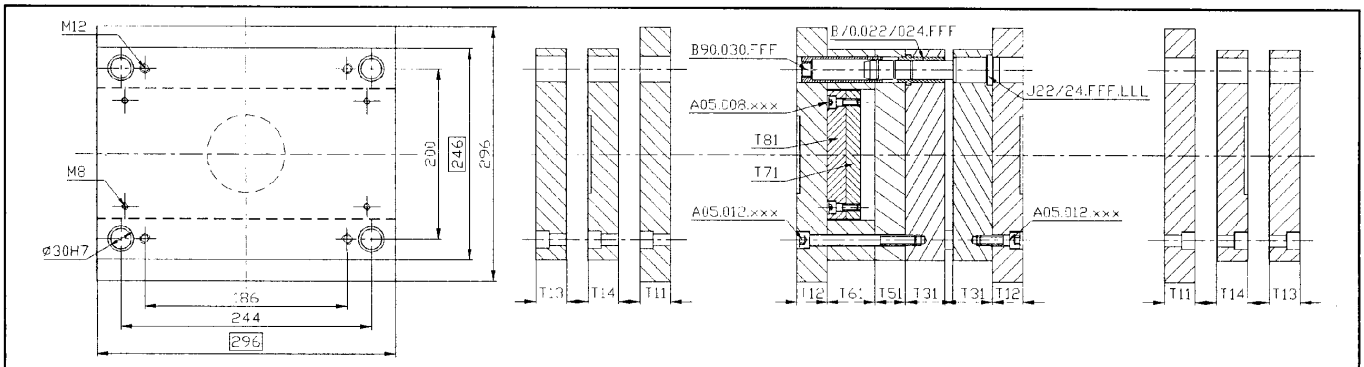

M	A	B	C	D	E
E	1730	2312	2311	2767	2162
27					
36					

M	A	B	C	D	E
E	1730	2312	2311	2767	2162
22					
27					

M	A	B	C	D	E
E	1730	2312	2311	2767	2162
27					
36					
46					
56					
66					
76					
86					
96					
116					

M	A	B	C	D	E
E	1730	2312	2311	2767	2162
36					

M	A	B	C	D	E
E	1730	2312	2311	2767	2162
56					
76					
96					

M	A	B	C	D	E
E	1730	2312	2311	2767	2162
12					

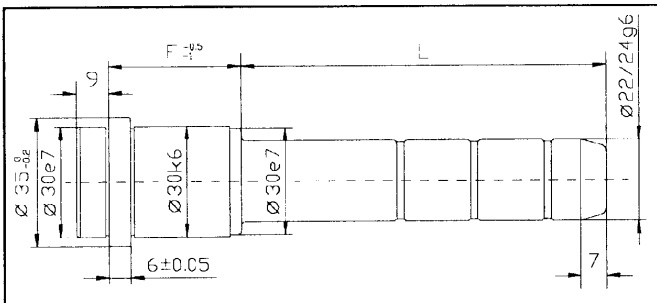
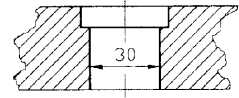

J.22.FFF.LLL / J.24.FFF.LLL						
F	L	Nr ø/Ø	F	L	Nr ø/Ø	
27	45	J 22 / 24 .027.045	66	55	J 22 / 24 .066.055	
	65	J 22 / 24 .027.065		75	J 22 / 24 .066.075	
	105	J 22 / 24 .027.105		95	J 22 / 24 .066.095	
36	55	J 22 / 24 .036.055	76	135	J 22 / 24 .066.135	
	75	J 22 / 24 .036.075		155	J 22 / 24 .066.155	
	105	J 22 / 24 .036.105		195	J 22 / 24 .066.195	
	135	J 22 / 24 .036.135		55	J 22 / 24 .076.055	
	165	J 22 / 24 .036.165		75	J 22 / 24 .076.075	
46	65	J 22 / 24 .046.065	86	95	J 22 / 24 .076.095	
	85	J 22 / 24 .046.085		115	J 22 / 24 .076.115	
	105	J 22 / 24 .046.105		145	J 22 / 24 .076.145	
	125	J 22 / 24 .046.125		195	J 22 / 24 .076.195	
	165	J 22 / 24 .046.165		75	J 22 / 24 .086.075	
56	205	J 22 / 24 .046.205	96	95	J 22 / 24 .086.095	
	55	J 22 / 24 .056.055		135	J 22 / 24 .086.135	
	75	J 22 / 24 .056.075		75	J 22 / 24 .096.075	
	95	J 22 / 24 .056.095		95	J 22 / 24 .096.095	
	115	J 22 / 24 .056.115		116	75	J 22 / 24 .116.075
	165	J 22 / 24 .056.165		115	J 22 / 24 .116.115	
	205	J 22 / 24 .056.205		136	95	J 22 / 24 .136.095
				135	J 22 / 24 .136.135	

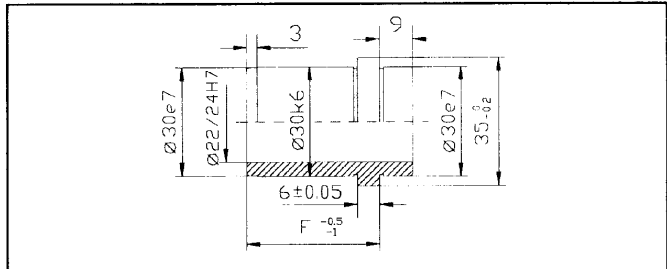

B70.022.OFF / B70.024.OFF			
F	Nr ø/Ø	F	Nr ø/Ø
27	B70.0 22 / 24 .027	76	B70.0 22 / 24 .076
36	B70.0 22 / 24 .036	86	B70.0 22 / 24 .086
46	B70.0 22 / 24 .046	96	B70.0 22 / 24 .096
56	B70.0 22 / 24 .056	116	B70.0 22 / 24 .116
66	B70.0 22 / 24 .066	136	B70.0 22 / 24 .136

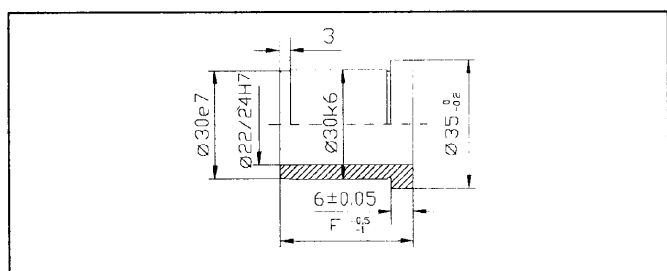

B80.022.OFF / B80.024.OFF			
F	Nr ø/Ø	F	Nr ø/Ø
27	B80.0 22 / 24 .027	76	B80.0 22 / 24 .076
36	B80.0 22 / 24 .036	86	B80.0 22 / 24 .086
46	B80.0 22 / 24 .046	96	B80.0 22 / 24 .096
56	B80.0 22 / 24 .056	116	B80.0 22 / 24 .116
66	B80.0 22 / 24 .066	136	B80.0 22 / 24 .136

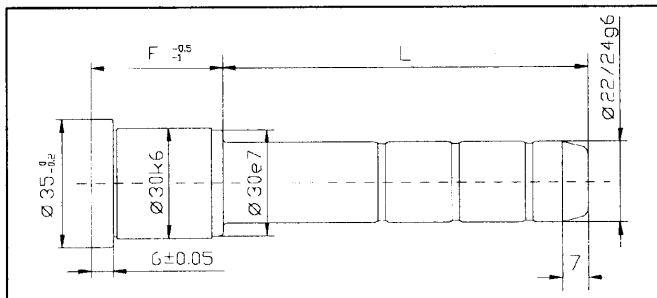

K22.FFF.LLL / K24.FFF.LLL						
F	L	Nr ø/Ø	F	L	Nr ø/Ø	
27	45	K 22 / 24 .027.045	66	55	K 22 / 24 .066.055	
	65	K 22 / 24 .027.065		75	K 22 / 24 .066.075	
	105	K 22 / 24 .027.105		95	K 22 / 24 .066.095	
36	55	K 22 / 24 .036.055	76	135	K 22 / 24 .066.135	
	75	K 22 / 24 .036.075				
	105	K 22 / 24 .036.105				
46	135	K 22 / 24 .036.135	86	55	K 22 / 24 .076.055	
				75	K 22 / 24 .076.075	
	65	K 22 / 24 .046.065		95	K 22 / 24 .076.095	
	85	K 22 / 24 .046.085		115	K 22 / 24 .076.115	
	105	K 22 / 24 .046.105				
56	125	K 22 / 24 .046.125	96	75	K 22 / 24 .086.075	
				95	K 22 / 24 .086.095	
	55	K 22 / 24 .056.055		135	K 22 / 24 .086.135	
	75	K 22 / 24 .056.075		96	75	K 22 / 24 .096.075
	95	K 22 / 24 .056.095		96	95	K 22 / 24 .096.095
	115	K 22 / 24 .056.115		116	75	K 22 / 24 .116.075
				115	K 22 / 24 .116.115	
				136	135	K 22 / 24 .136.135

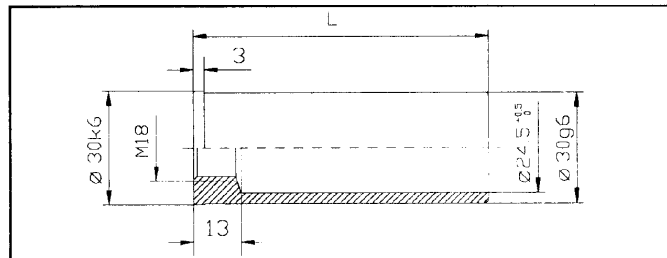

B90.030.LLL			
F	Nr	L	Nr
60	B90.030.060	140	B90.030.140
80	B90.030.080	160	B90.030.160
100	B90.030.100	180	B90.030.180
120	B90.030.120		

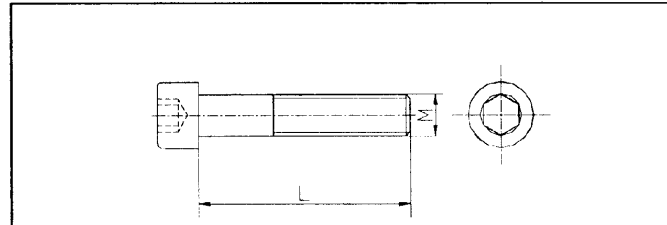

A05.xxx.xxx					
M x L	Nr	M x L	Nr	M x L	Nr
8x16	A05.008.016	12x25	A05.012.025	12x90	A05.012.090
		12x30	A05.012.030	12x100	A05.012.100
		12x35	A05.012.035	12x120	A05.012.120
		12x45	A05.012.045	12x130	A05.012.130
		12x50	A05.012.050	12x140	A05.012.140
		12x55	A05.012.055	12x150	A05.012.150
		12x60	A05.012.060	12x160	A05.012.160
		12x65	A05.012.065	12x180	A05.012.180
		12x70	A05.012.070	12x200	A05.012.200
		12x80	A05.012.080		

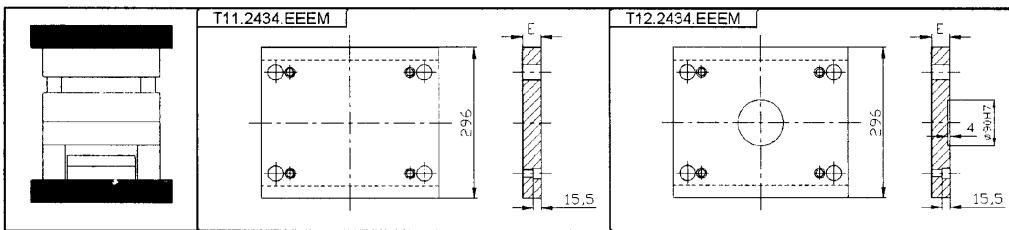
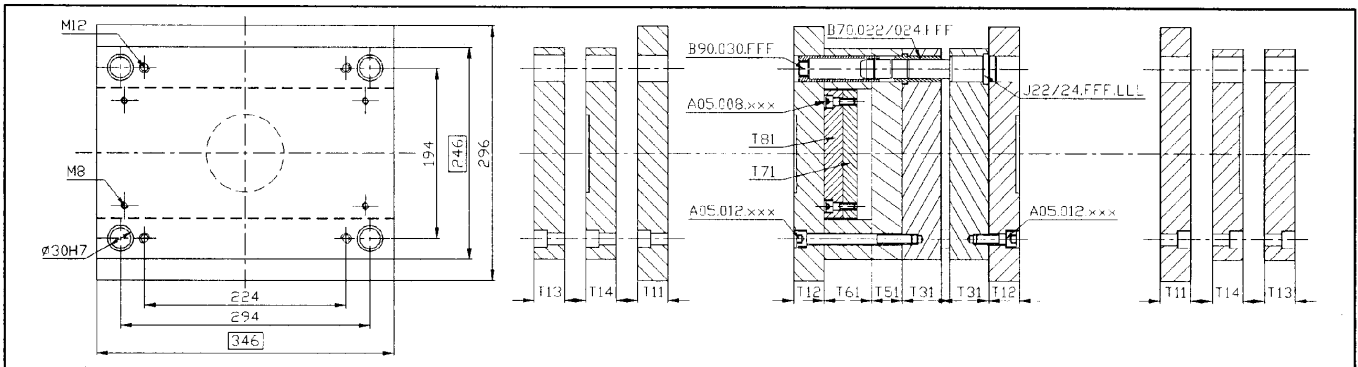

M	A	B	C	D	E
E	1730	2312	2311	2767	2162
27					
36					

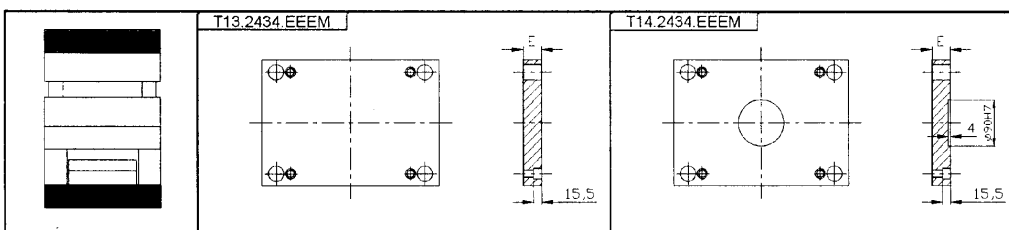

M	A	B	C	D	E
E	1730	2312	2311	2767	2162
22					
27					

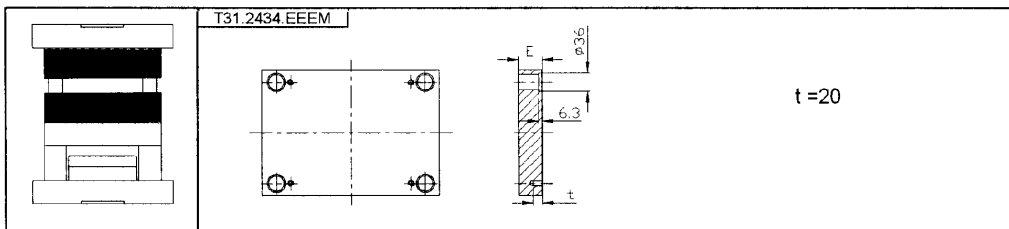

M	A	B	C	D	E
E	1730	2312	2311	2767	2162
27					
36					
46					
56					
66					
76					
86					
96					
116					

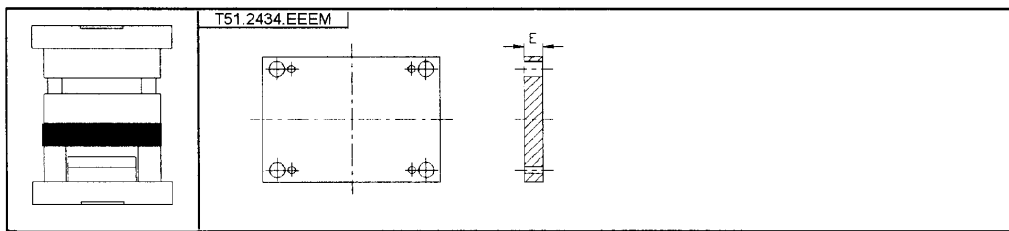

M	A	B	C	D	E
E	1730	2312	2311	2767	2162
36					
46					

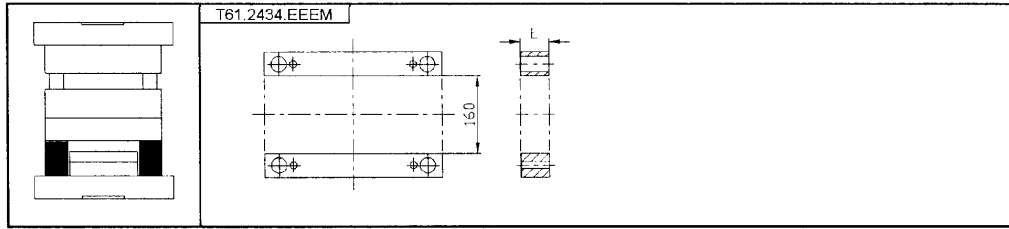

M	A	B	C	D	E
E	1730	2312	2311	2767	2162
56					
76					
96					

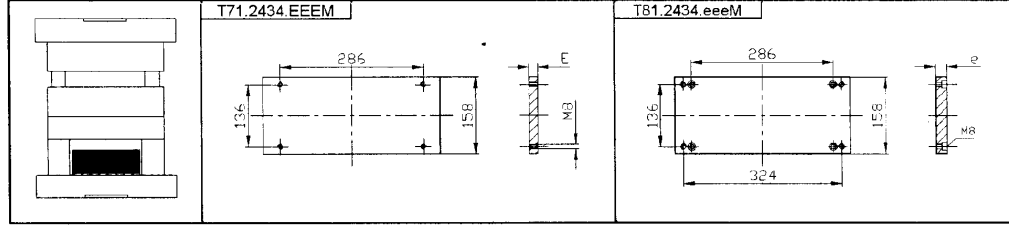

M	A	B	C	D	E
E	1730	2312	2311	2767	2162
17					

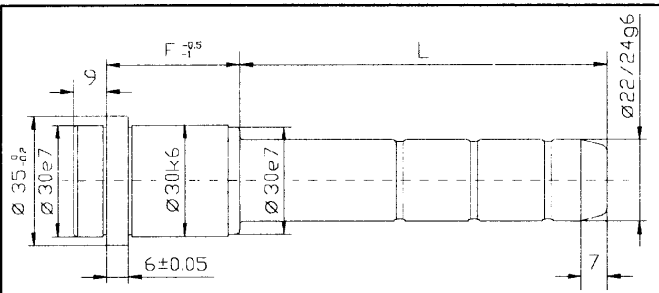
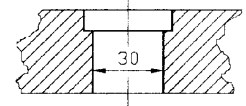

J.22.FFF.LLL / J.24.FFF.LLL								
F	L	Nr	Ø / Ø	F	L	Nr	Ø / Ø	
27	45	J 22 / 24	027.045	66	55	J 22 / 24	066.055	
	65	J 22 / 24	027.065		75	J 22 / 24	066.075	
	105	J 22 / 24	027.105		95	J 22 / 24	066.095	
36	55	J 22 / 24	036.055	76	135	J 22 / 24	076.135	
	75	J 22 / 24	036.075		155	J 22 / 24	076.155	
	105	J 22 / 24	036.105		195	J 22 / 24	076.195	
	135	J 22 / 24	036.135		55	J 22 / 24	076.055	
46	165	J 22 / 24	036.165	86	75	J 22 / 24	076.075	
	65	J 22 / 24	046.065		95	J 22 / 24	076.095	
	85	J 22 / 24	046.085		115	J 22 / 24	076.115	
	105	J 22 / 24	046.105		145	J 22 / 24	076.145	
	125	J 22 / 24	046.125		195	J 22 / 24	076.195	
56	165	J 22 / 24	046.165	96	75	J 22 / 24	086.075	
	205	J 22 / 24	046.205		95	J 22 / 24	086.095	
	55	J 22 / 24	056.055		135	J 22 / 24	086.135	
	75	J 22 / 24	056.075		96	75	J 22 / 24	096.075
	95	J 22 / 24	056.095		96	95	J 22 / 24	096.095
56	115	J 22 / 24	056.115	116	75	J 22 / 24	116.075	
	165	J 22 / 24	056.165		115	J 22 / 24	116.115	
	205	J 22 / 24	056.205		95	J 22 / 24	136.095	
					135	J 22 / 24	136.135	

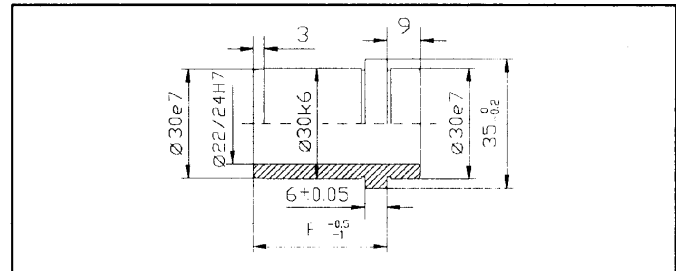

B70.022.OFF / B70.024.OFF							
F	Nr	Ø / Ø	F	Nr	Ø / Ø		
27	B70.0	22 / 24	027	76	B70.0	22 / 24	076
36	B70.0	22 / 24	036	86	B70.0	22 / 24	086
46	B70.0	22 / 24	046	96	B70.0	22 / 24	096
56	B70.0	22 / 24	056	116	B70.0	22 / 24	116
66	B70.0	22 / 24	066	136	B70.0	22 / 24	136

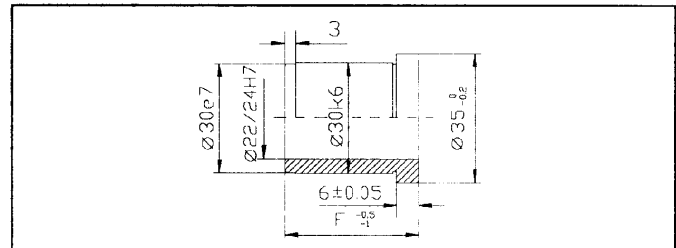

B80.022.OFF / B80.024.OFF							
F	Nr	Ø / Ø	F	Nr	Ø / Ø		
27	B80.0	22 / 24	027	76	B80.0	22 / 24	076
36	B80.0	22 / 24	036	86	B80.0	22 / 24	086
46	B80.0	22 / 24	046	96	B80.0	22 / 24	096
56	B80.0	22 / 24	056	116	B80.0	22 / 24	116
66	B80.0	22 / 24	066	136	B80.0	22 / 24	136

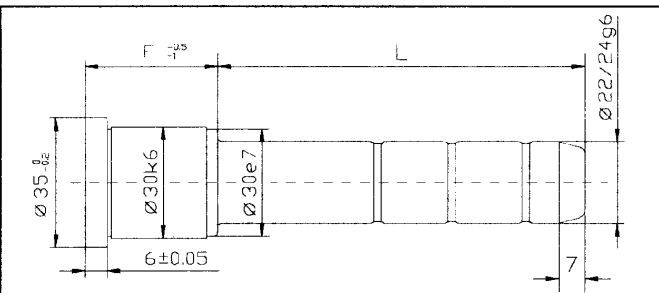

K.22.FFF.LLL / K.24.FFF.LLL								
F	L	Nr	Ø / Ø	F	L	Nr	Ø / Ø	
27	45	K 22 / 24	027.045	66	55	K 22 / 24	066.055	
	65	K 22 / 24	027.065		75	K 22 / 24	066.075	
	105	K 22 / 24	027.105		95	K 22 / 24	066.095	
36	55	K 22 / 24	036.055	76	135	K 22 / 24	076.135	
	75	K 22 / 24	036.075		55	K 22 / 24	076.055	
	105	K 22 / 24	036.105		75	K 22 / 24	076.075	
	135	K 22 / 24	036.135		95	K 22 / 24	076.095	
46	165	K 22 / 24	036.165	86	115	K 22 / 24	076.115	
	65	K 22 / 24	046.065		75	K 22 / 24	086.075	
	85	K 22 / 24	046.085		95	K 22 / 24	086.095	
	105	K 22 / 24	046.105		135	K 22 / 24	086.135	
	125	K 22 / 24	046.125		96	75	K 22 / 24	096.075
56	165	K 22 / 24	046.165	96	95	K 22 / 24	096.095	
	205	K 22 / 24	046.205		116	75	K 22 / 24	116.075
	55	K 22 / 24	056.055		116	115	K 22 / 24	116.115
	75	K 22 / 24	056.075		136	135	K 22 / 24	136.135
	95	K 22 / 24	056.095					

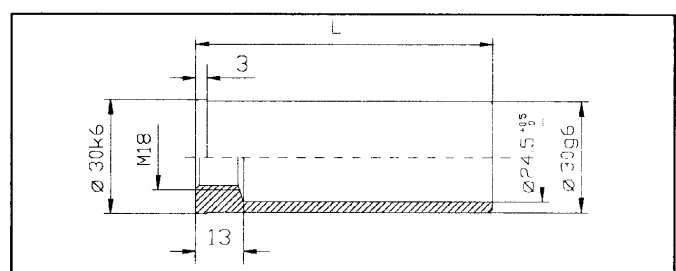

B90.030.LLL			
F	Nr	L	Nr
60	B90.030.060	140	B90.030.140
80	B90.030.080	160	B90.030.160
100	B90.030.100	180	B90.030.180
120	B90.030.120		

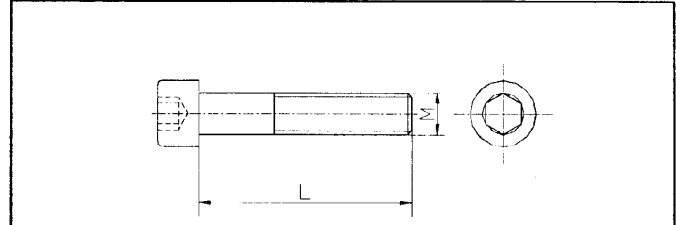

A05.xxx.xxx					
M x L	Nr	M x L	Nr	M x L	Nr
8x25	A05.008.025	12x25	A05.012.025	12x90	A05.012.090
		12x30	A05.012.030	12x100	A05.012.100
		12x35	A05.012.035	12x120	A05.012.120
		12x45	A05.012.045	12x130	A05.012.130
		12x50	A05.012.050	12x140	A05.012.140
		12x55	A05.012.055	12x150	A05.012.150
		12x60	A05.012.060	12x160	A05.012.160
		12x65	A05.012.065	12x180	A05.012.180
		12x70	A05.012.070	12x200	A05.012.200
		12x80	A05.012.080		

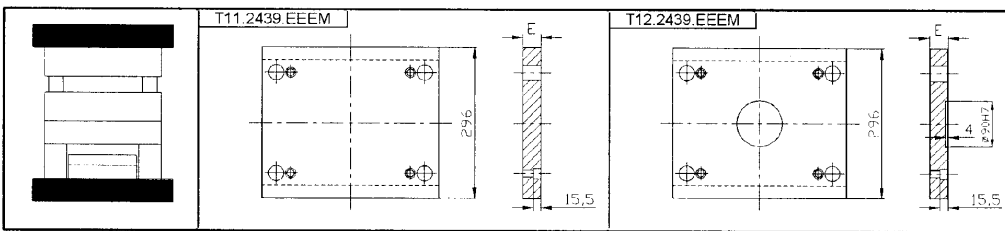
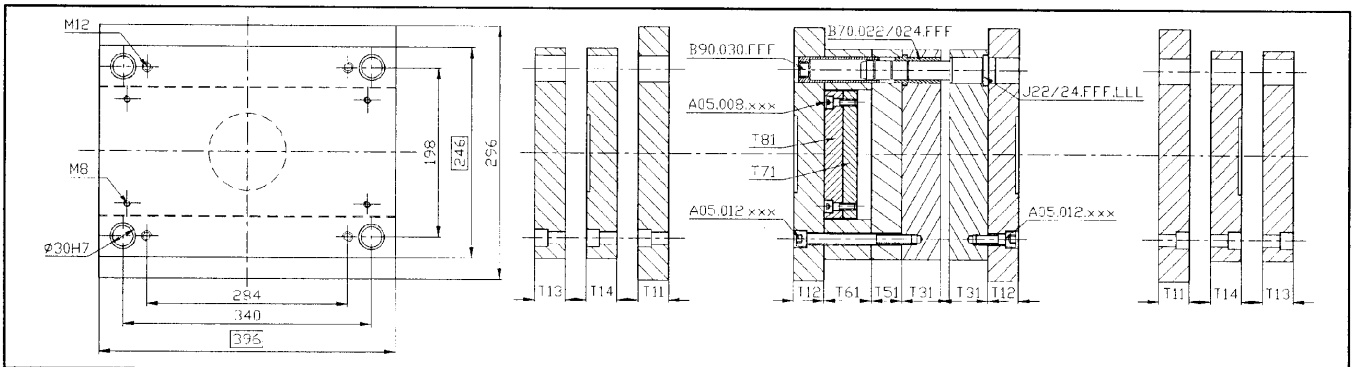

M	A	B	C	D	E
E	1730	2312	2311	2767	2162
27					
36					

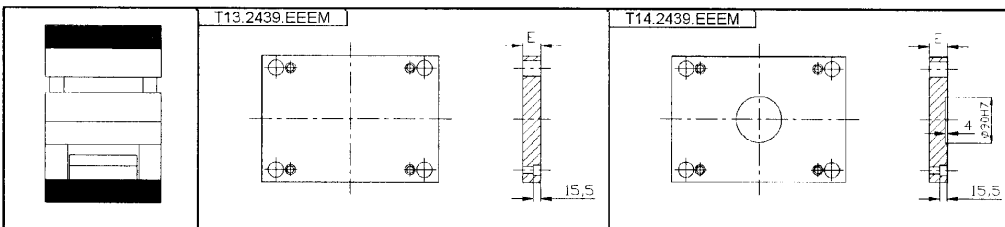

M	A	B	C	D	E
E	1730	2312	2311	2767	2162
22					
27					

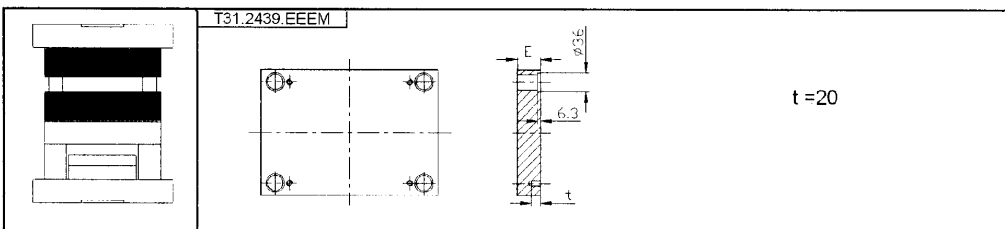

M	A	B	C	D	E
E	1730	2312	2311	2767	2162
27					
36					
46					
56					
66					
76					
86					
96					
116					

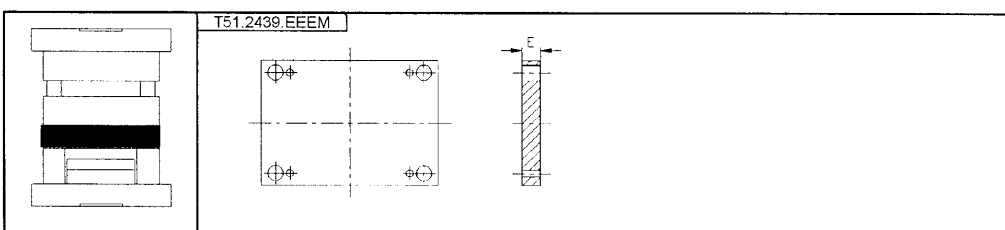

M	A	B	C	D	E
E	1730	2312	2311	2767	2162
36					
46					

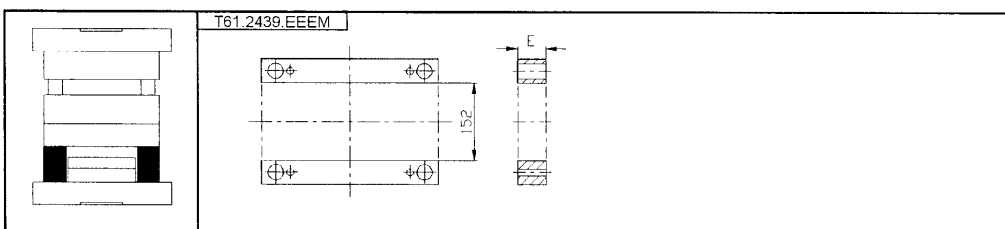

M	A	B	C	D	E
E	1730	2312	2311	2767	2162
56					
76					
96					

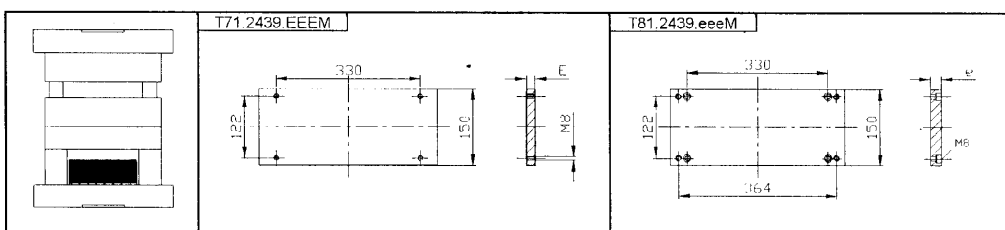

M	A	B	C	D	E
E	1730	2312	2311	2767	2162
17					



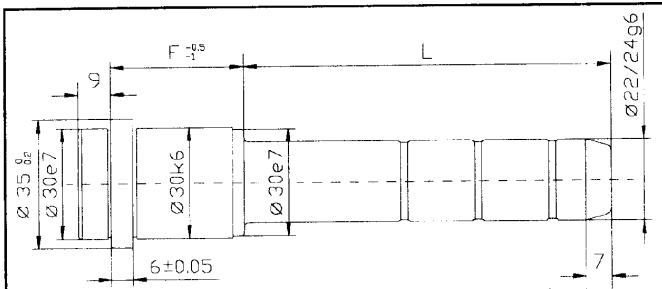
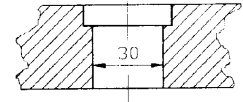

J.22.FFF.LLL / J.24.FFF.LLL					
F	L	Nr ø/Ø	F	L	Nr ø/Ø
27	45	J 22/24.027.045	66	55	J 22/24.066.055
	65	J 22/24.027.065		75	J 22/24.066.075
	105	J 22/24.027.105		95	J 22/24.066.095
36	55	J 22/24.036.055	76	135	J 22/24.076.135
	75	J 22/24.036.075		155	J 22/24.076.155
	105	J 22/24.036.105		195	J 22/24.076.195
	135	J 22/24.036.135		55	J 22/24.076.055
46	65	J 22/24.046.065	86	75	J 22/24.086.075
	85	J 22/24.046.085		95	J 22/24.086.095
	105	J 22/24.046.105		115	J 22/24.086.115
	125	J 22/24.046.125		145	J 22/24.086.145
	165	J 22/24.046.165		195	J 22/24.086.195
56	205	J 22/24.046.205	96	75	J 22/24.096.075
	55	J 22/24.056.055		95	J 22/24.096.095
	75	J 22/24.056.075		135	J 22/24.096.135
	95	J 22/24.056.095		116	J 22/24.116.075
	115	J 22/24.056.115		115	J 22/24.116.115
	165	J 22/24.056.165	136	95	J 22/24.136.095
	205	J 22/24.056.205		135	J 22/24.136.135

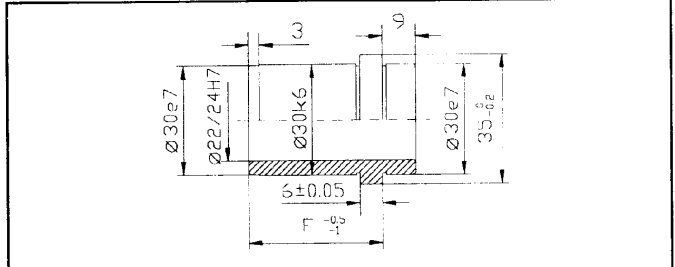

B70.022.OFF / B70.024.OFF			
F	Nr ø/Ø	F	Nr ø/Ø
27	B70.022/24.027	76	B70.022/24.076
36	B70.022/24.036	86	B70.022/24.086
46	B70.022/24.046	96	B70.022/24.096
56	B70.022/24.056	116	B70.022/24.116
66	B70.022/24.066	136	B70.022/24.136

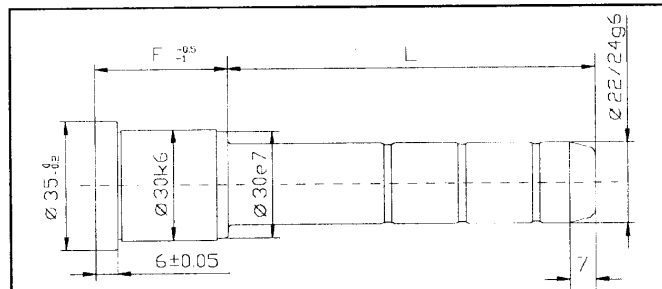

K22.FFF.LLL / K24.FFF.LLL					
F	L	Nr ø/Ø	F	L	Nr ø/Ø
27	45	K 22/24.027.045	66	55	K 22/24.066.055
	65	K 22/24.027.065		75	K 22/24.066.075
	105	K 22/24.027.105		95	K 22/24.066.095
36	55	K 22/24.036.055	76	135	K 22/24.076.135
	75	K 22/24.036.075		155	K 22/24.076.155
	105	K 22/24.036.105		195	K 22/24.076.195
	135	K 22/24.036.135		55	K 22/24.076.055
46	65	K 22/24.046.065	86	75	K 22/24.086.075
	85	K 22/24.046.085		95	K 22/24.086.095
	105	K 22/24.046.105		115	K 22/24.086.115
	125	K 22/24.046.125		145	K 22/24.086.145
	165	K 22/24.046.165		195	K 22/24.086.195
56	205	K 22/24.046.205	96	75	K 22/24.096.075
	55	K 22/24.056.055		95	K 22/24.096.095
	75	K 22/24.056.075		135	K 22/24.096.135
	95	K 22/24.056.095		116	K 22/24.116.075
	115	K 22/24.056.115		115	K 22/24.116.115
	165	K 22/24.056.165	136	95	K 22/24.136.095
	205	K 22/24.056.205		135	K 22/24.136.135

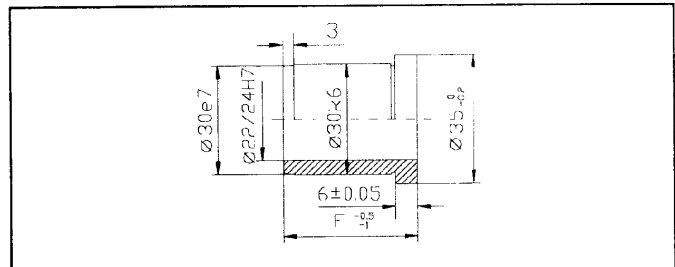

B80.022.OFF / B80.024.OFF			
F	Nr ø/Ø	F	Nr ø/Ø
27	B80.022/24.027	76	B80.022/24.076
36	B80.022/24.036	86	B80.022/24.086
46	B80.022/24.046	96	B80.022/24.096
56	B80.022/24.056	116	B80.022/24.116
66	B80.022/24.066	136	B80.022/24.136

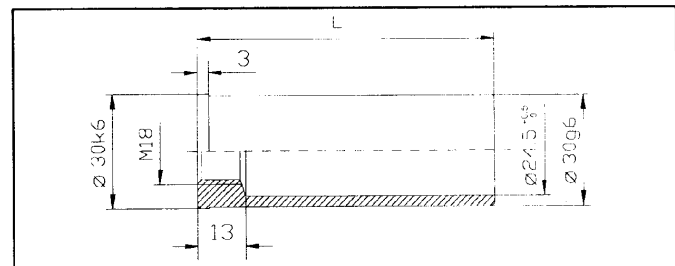

B90.030.LLL			
F	Nr	L	Nr
60	B90.030.060	140	B90.030.140
80	B90.030.080	160	B90.030.160
100	B90.030.100	180	B90.030.180
120	B90.030.120		

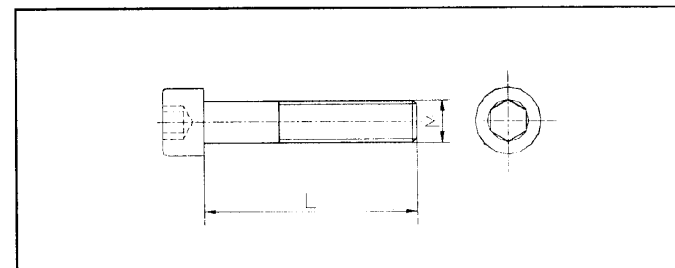

A05.xxx.xxx					
M x L	Nr	M x L	Nr	M x L	Nr
8x25	A05.008.025	12x25	A05.012.025	12x90	A05.012.090
		12x30	A05.012.030	12x100	A05.012.100
		12x35	A05.012.035	12x120	A05.012.120
		12x45	A05.012.045	12x130	A05.012.130
		12x50	A05.012.050	12x140	A05.012.140
		12x55	A05.012.055	12x150	A05.012.150
		12x60	A05.012.060	12x160	A05.012.160
		12x65	A05.012.065	12x180	A05.012.180
		12x70	A05.012.070	12x200	A05.012.200
		12x80	A05.012.080		

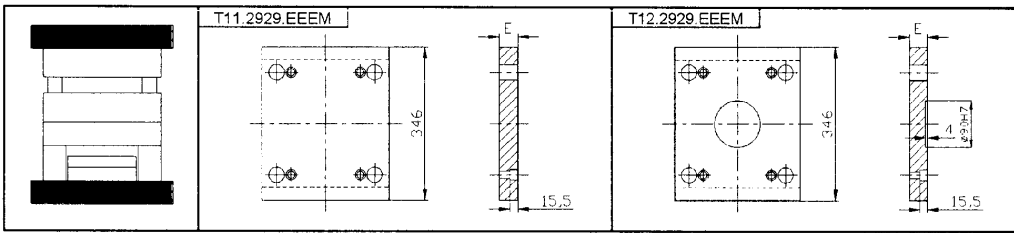
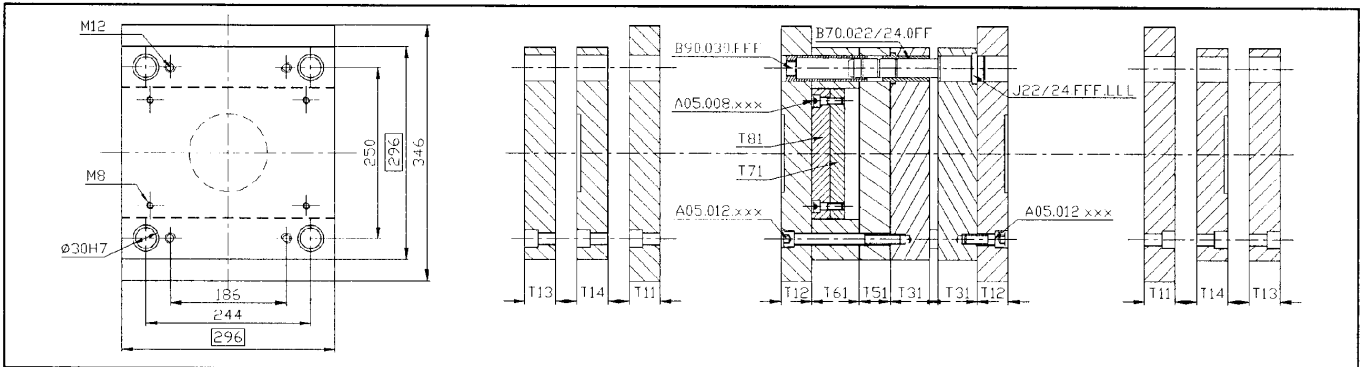

M	A	B	C	D	E
E	1730	2312	2311	2767	2162
27					
36					

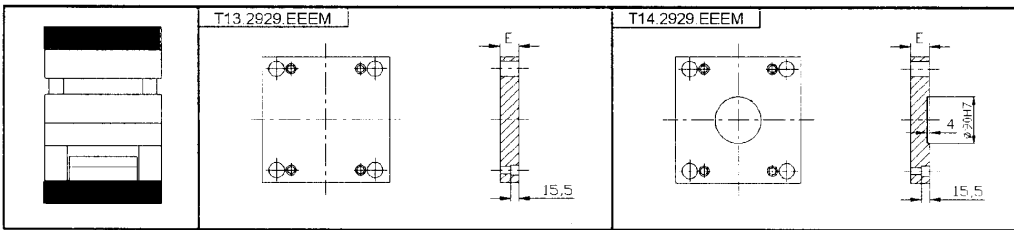

M	A	B	C	D	E
E	1730	2312	2311	2767	2162
22					
27					

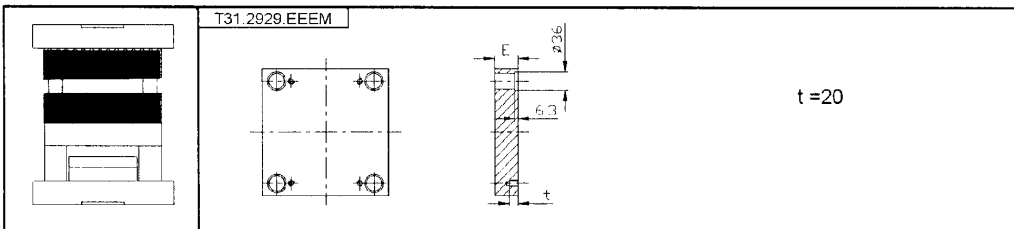

M	A	B	C	D	E
E	1730	2312	2311	2767	2162
27					
36					
46					
56					
66					
76					
86					
96					
116					

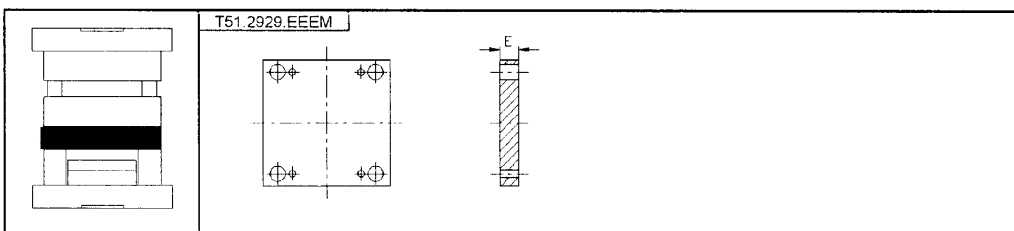

M	A	B	C	D	E
E	1730	2312	2311	2767	2162
36					
46					

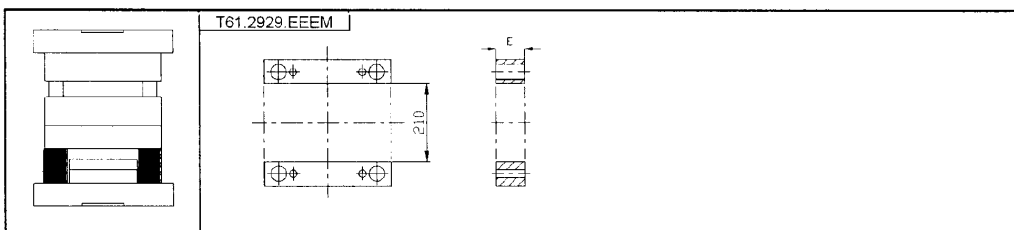

M	A	B	C	D	E
E	1730	2312	2311	2767	2162
56					
76					
96					

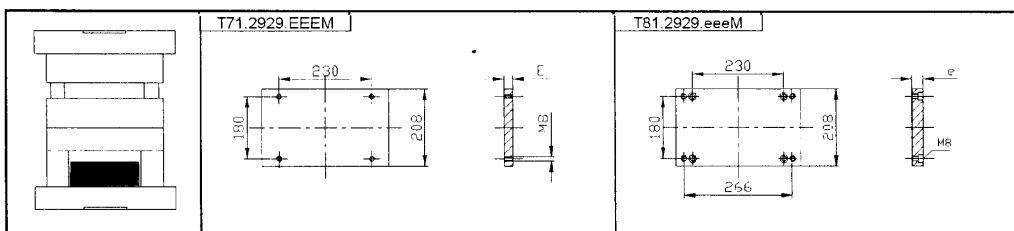

M	A	B	C	D	E
E	1730	2312	2311	2767	2162
12					



Ø 22 / Ø 24

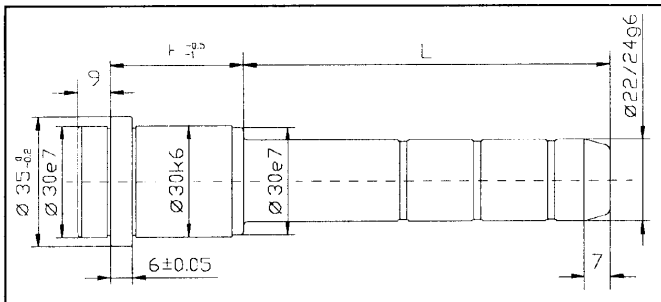
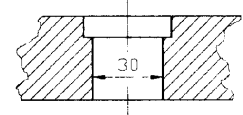

J.22.FFF.LLL / J.24.FFF.LLL					
F	L	Nr ø / Ø	F	L	Nr ø / Ø
27	45	J 22 / 24 .027.045	66	55	J 22 / 24 .066.055
	65	J 22 / 24 .027.065		75	J 22 / 24 .066.075
	105	J 22 / 24 .027.105		95	J 22 / 24 .066.095
36	55	J 22 / 24 .036.055	76	135	J 22 / 24 .066.135
	75	J 22 / 24 .036.075		155	J 22 / 24 .066.155
	105	J 22 / 24 .036.105		195	J 22 / 24 .066.195
	135	J 22 / 24 .036.135		55	J 22 / 24 .076.055
46	165	J 22 / 24 .036.165	86	75	J 22 / 24 .076.075
	65	J 22 / 24 .046.065		95	J 22 / 24 .076.095
	85	J 22 / 24 .046.085		115	J 22 / 24 .076.115
	105	J 22 / 24 .046.105		145	J 22 / 24 .076.145
	125	J 22 / 24 .046.125		195	J 22 / 24 .076.195
56	165	J 22 / 24 .046.165	96	75	J 22 / 24 .086.075
	205	J 22 / 24 .046.205		95	J 22 / 24 .086.095
	55	J 22 / 24 .056.055		135	J 22 / 24 .086.135
	75	J 22 / 24 .056.075		75	J 22 / 24 .096.075
	95	J 22 / 24 .056.095		95	J 22 / 24 .096.095
27	115	J 22 / 24 .056.115	116	75	J 22 / 24 .116.075
	165	J 22 / 24 .056.165		115	J 22 / 24 .116.115
	205	J 22 / 24 .056.205		136	95
				135	J 22 / 24 .136.135

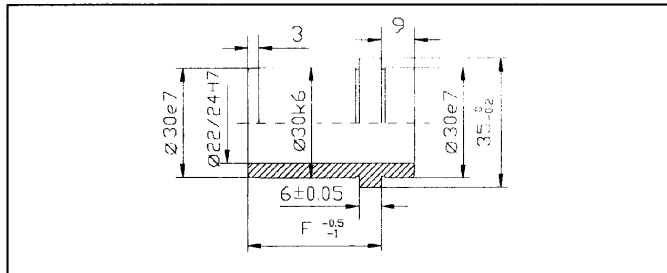

B70.022.OFF / B70.024.OFF			
F	Nr ø / Ø	F	Nr ø / Ø
27	B70.022/24.027	76	B70.022/24.076
36	B70.022/24.036	86	B70.022/24.086
46	B70.022/24.046	96	B70.022/24.096
56	B70.022/24.056	116	B70.022/24.116
66	B70.022/24.066	136	B70.022/24.136

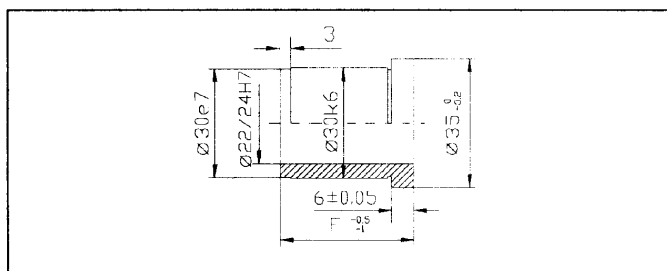

B80.022.OFF / B80.024.OFF			
F	Nr ø / Ø	F	Nr ø / Ø
27	B80.022/24.027	76	B80.022/24.076
36	B80.022/24.036	86	B80.022/24.086
46	B80.022/24.046	96	B80.022/24.096
56	B80.022/24.056	116	B80.022/24.116
66	B80.022/24.066	136	B80.022/24.136

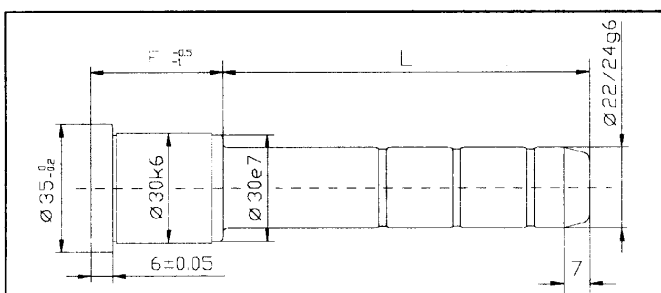

K22.FFF.LLL / K24.FFF.LLL					
F	L	Nr ø / Ø	F	L	Nr ø / Ø
27	45	K 22 / 24 .027.045	66	55	K 22 / 24 .066.055
	65	K 22 / 24 .027.065		75	K 22 / 24 .066.075
	105	K 22 / 24 .027.105		95	K 22 / 24 .066.095
36	55	K 22 / 24 .036.055	76	135	K 22 / 24 .066.135
	75	K 22 / 24 .036.075			
	105	K 22 / 24 .036.105			
	135	K 22 / 24 .036.135			
46	65	K 22 / 24 .046.065	86	55	K 22 / 24 .076.055
	85	K 22 / 24 .046.085		75	K 22 / 24 .076.075
	105	K 22 / 24 .046.105		95	K 22 / 24 .076.095
	125	K 22 / 24 .046.125		115	K 22 / 24 .076.115
56			96	75	K 22 / 24 .086.075
	55	K 22 / 24 .056.055		95	K 22 / 24 .086.095
	75	K 22 / 24 .056.075		135	K 22 / 24 .086.135
	95	K 22 / 24 .056.095		75	K 22 / 24 .096.075
	115	K 22 / 24 .056.115		95	K 22 / 24 .096.095
		116	75	K 22 / 24 .116.075	
			115	K 22 / 24 .116.115	
			136	135	K 22 / 24 .136.135

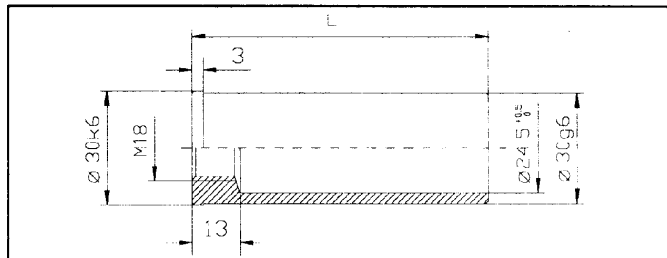

B90.030.LLL			
F	Nr	L	Nr
60	B90.030.060	140	B90.030.140
80	B90.030.080	160	B90.030.160
100	B90.030.100	180	B90.030.180
120	B90.030.120		

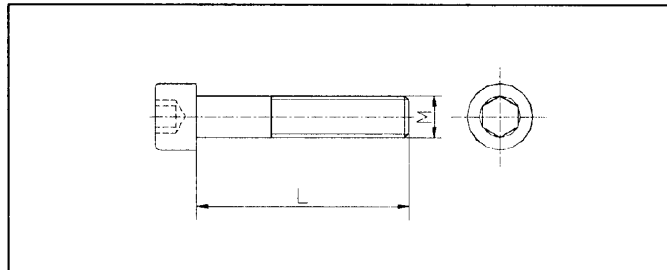

A05.xxx.xxx							
M x L	Nr	M x L	Nr	M x L	Nr		
8x16	A05.008.016	12x25	A05.012.025	12x90	A05.012.090		
		12x30	A05.012.030	12x100	A05.012.100		
		12x35	A05.012.035	12x120	A05.012.120		
		12x45	A05.012.045	12x130	A05.012.130		
		12x50	A05.012.050	12x140	A05.012.140		
		12x55	A05.012.055	12x150	A05.012.150		
		12x60	A05.012.060	12x160	A05.012.160		
		12x65	A05.012.065	12x180	A05.012.180		
		12x70	A05.012.070	12x200	A05.012.200		

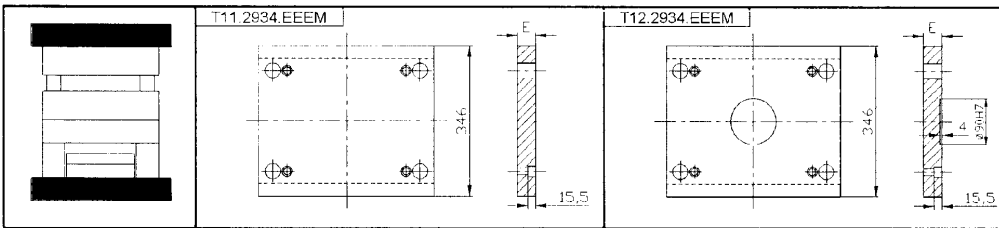
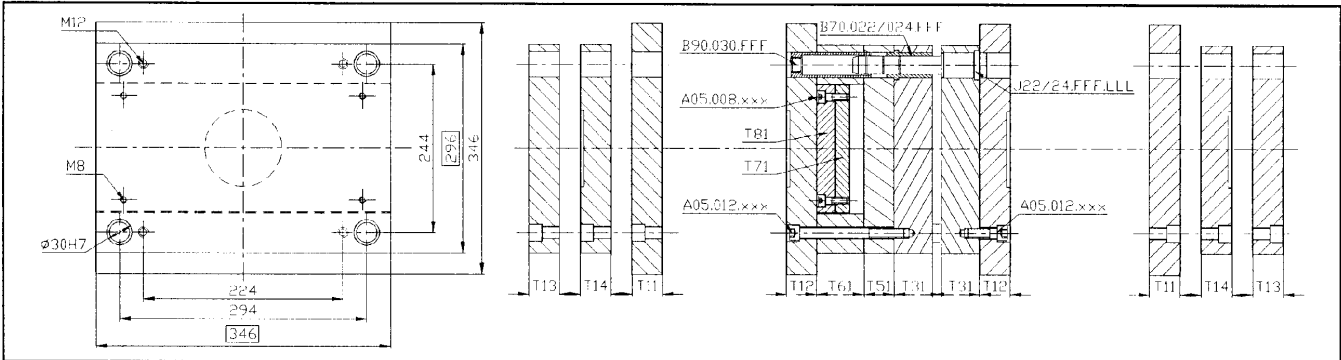

M	A	B	C	D	E
E	1730	2312	2311	2767	2162
27					
36					

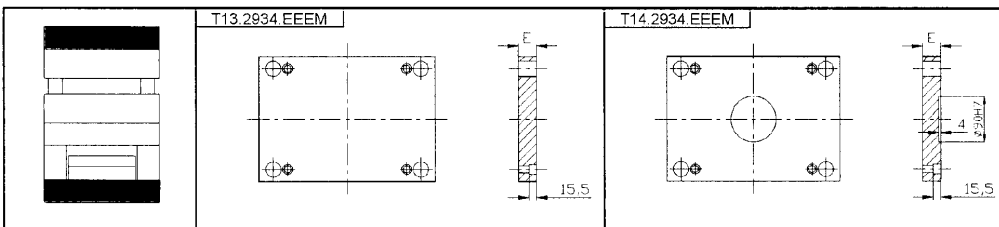

M	A	B	C	D	E
E	1730	2312	2311	2767	2162
22					
27					

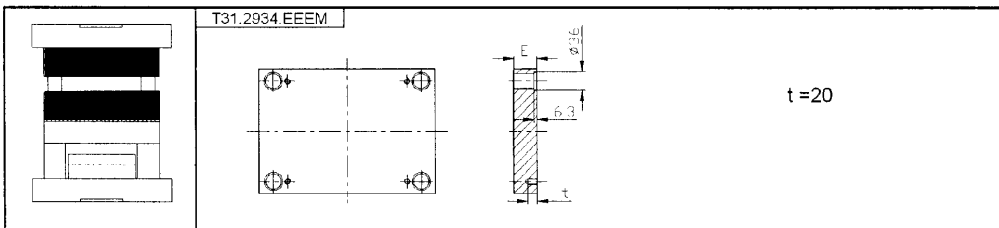

M	A	B	C	D	E
E	1730	2312	2311	2767	2162
27					
36					
46					
56					
66					
86					
96					
116					

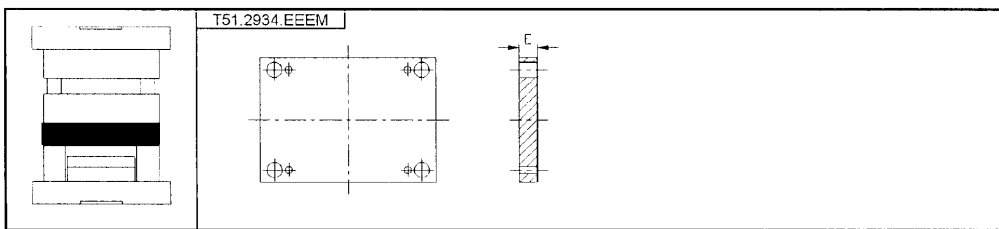

M	A	B	C	D	E
E	1730	2312	2311	2767	2162
36					
46					

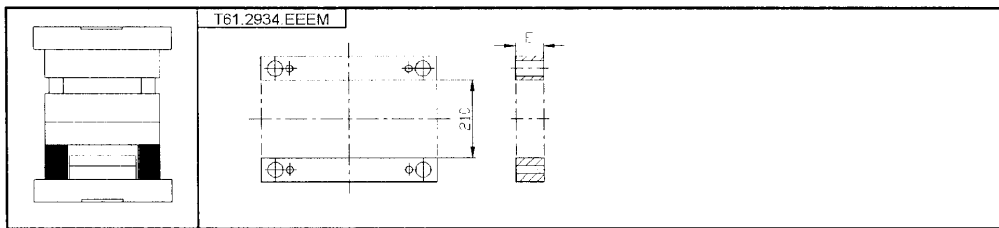

M	A	B	C	D	E
E	1730	2312	2311	2767	2162
56					
76					
96					

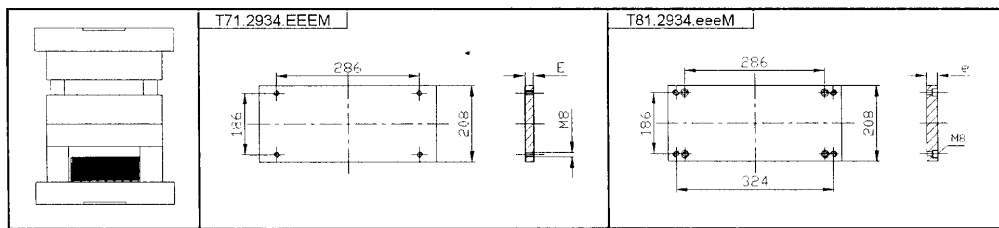

M	A	B	C	D	E
E	1730	2312	2311	2767	2162
17					



Ø 22 / Ø 24

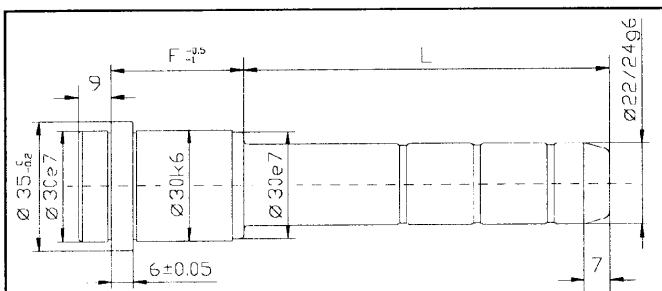
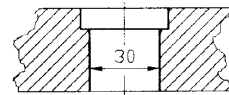

J.22.FFF.LLL / J.24.FFF.LLL

F	L	Nr ø / Ø	F	L	Nr ø / Ø
27	45	J 22 / 24 .027.045	66	55	J 22 / 24 .066.055
	65	J 22 / 24 .027.065		75	J 22 / 24 .066.075
	105	J 22 / 24 .027.105		95	J 22 / 24 .066.095
36	55	J 22 / 24 .036.055	76	135	J 22 / 24 .066.135
	75	J 22 / 24 .036.075		155	J 22 / 24 .066.155
	105	J 22 / 24 .036.105		195	J 22 / 24 .066.195
	135	J 22 / 24 .036.135		55	J 22 / 24 .076.055
46	165	J 22 / 24 .036.165	86	75	J 22 / 24 .076.075
	65	J 22 / 24 .046.065		95	J 22 / 24 .076.095
	85	J 22 / 24 .046.085		115	J 22 / 24 .076.115
	105	J 22 / 24 .046.105		145	J 22 / 24 .076.145
	125	J 22 / 24 .046.125		195	J 22 / 24 .076.195
56	165	J 22 / 24 .046.165	116	75	J 22 / 24 .086.075
	205	J 22 / 24 .046.205		95	J 22 / 24 .086.095
	55	J 22 / 24 .056.055		135	J 22 / 24 .086.135
	75	J 22 / 24 .056.075		75	J 22 / 24 .096.075
	95	J 22 / 24 .056.095		95	J 22 / 24 .096.095
	115	J 22 / 24 .056.115		75	J 22 / 24 .116.075
	165	J 22 / 24 .056.165	116	115	J 22 / 24 .116.115
	205	J 22 / 24 .056.205	136	95	J 22 / 24 .136.095
				135	J 22 / 24 .136.135

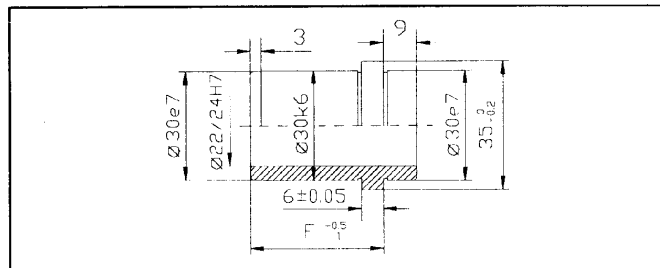

B70.022.0FF / B70.024.0FF

F	Nr ø / Ø	F	Nr ø / Ø
27	B70.0 22 / 24 .027	76	B70.0 22 / 24 .076
36	B70.0 22 / 24 .036	86	B70.0 22 / 24 .086
46	B70.0 22 / 24 .046	96	B70.0 22 / 24 .096
56	B70.0 22 / 24 .056	116	B70.0 22 / 24 .116
66	B70.0 22 / 24 .066	136	B70.0 22 / 24 .136

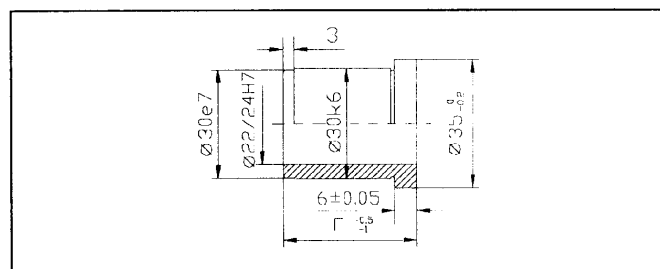

B80.022.0FF / B80.024.0FF

F	Nr ø / Ø	F	Nr ø / Ø
27	B80.0 22 / 24 .027	76	B80.0 22 / 24 .076
36	B80.0 22 / 24 .036	86	B80.0 22 / 24 .086
46	B80.0 22 / 24 .046	96	B80.0 22 / 24 .096
56	B80.0 22 / 24 .056	116	B80.0 22 / 24 .116
66	B80.0 22 / 24 .066	136	B80.0 22 / 24 .136

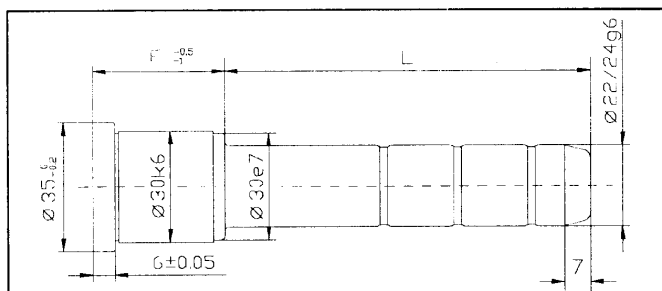

K22.FFF.LLL / K24.FFF.LLL

F	L	Nr ø / Ø	F	L	Nr ø / Ø
27	45	K 22 / 24 .027.045	66	55	K 22 / 24 .066.055
	65	K 22 / 24 .027.065		75	K 22 / 24 .066.075
	105	K 22 / 24 .027.105		95	K 22 / 24 .066.095
36	55	K 22 / 24 .036.055	76	135	K 22 / 24 .066.135
	75	K 22 / 24 .036.075		55	K 22 / 24 .076.055
	105	K 22 / 24 .036.105		75	K 22 / 24 .076.075
	135	K 22 / 24 .036.135		95	K 22 / 24 .076.095
46	165	K 22 / 24 .036.165	86	115	K 22 / 24 .076.115
	65	K 22 / 24 .046.065		75	K 22 / 24 .086.075
	85	K 22 / 24 .046.085		95	K 22 / 24 .086.095
	105	K 22 / 24 .046.105		135	K 22 / 24 .086.135
	125	K 22 / 24 .046.125		75	K 22 / 24 .096.075
56			96	95	K 22 / 24 .096.095
	55	K 22 / 24 .056.055		135	K 22 / 24 .096.135
	75	K 22 / 24 .056.075		75	K 22 / 24 .116.075
	95	K 22 / 24 .056.095		95	K 22 / 24 .116.095
	115	K 22 / 24 .056.115		75	K 22 / 24 .116.115
				115	K 22 / 24 .116.115
		136	135	K 22 / 24 .136.135	

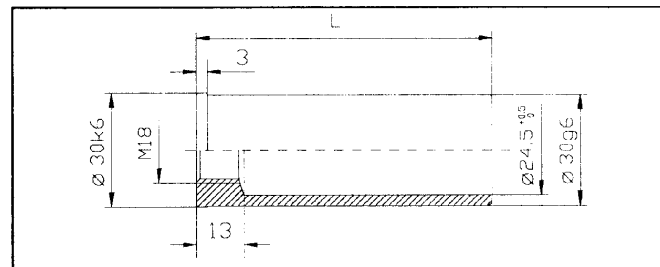

B90.030.LLL

F	Nr	L	Nr
60	B90.030.060	140	B90.030.140
80	B90.030.080	160	B90.030.160
100	B90.030.100	180	B90.030.180
120	B90.030.120		

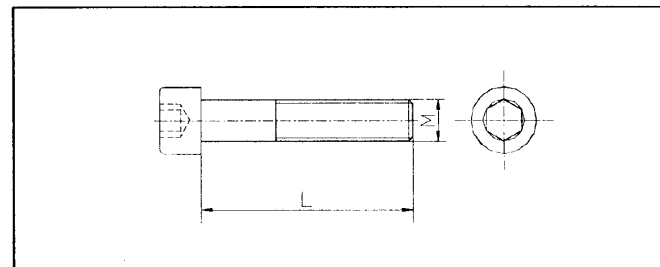

A05.xxx.xxx

M x L	Nr	M x L	Nr	M x L	Nr
8x25	A05.008.025	12x25	A05.012.025	12x60	A05.012.090
		12x30	A05.012.030	12x100	A05.012.100
		12x35	A05.012.035	12x120	A05.012.120
		12x45	A05.012.045	12x130	A05.012.130
		12x50	A05.012.050	12x140	A05.012.140
		12x55	A05.012.055	12x150	A05.012.150
		12x60	A05.012.060	12x160	A05.012.160
		12x65	A05.012.065	12x180	A05.012.180
		12x70	A05.012.070	12x200	A05.012.200
		12x80	A05.012.080		

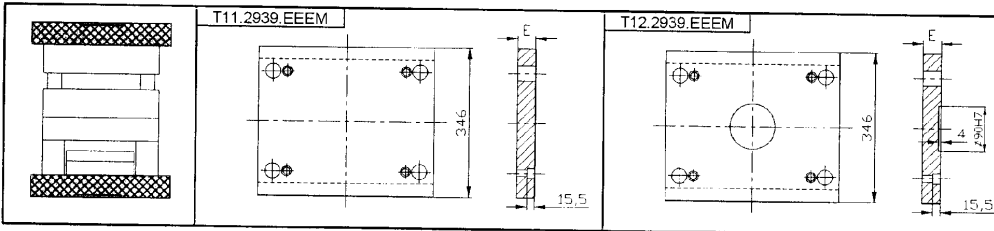
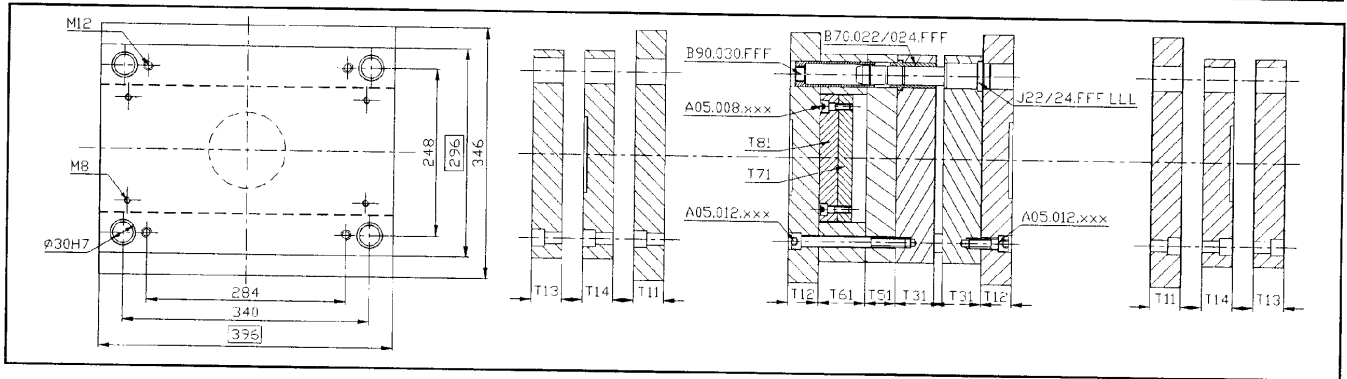

M	A	B	C	D	E
E	1730	2312	2311	2767	2162
27					
36					

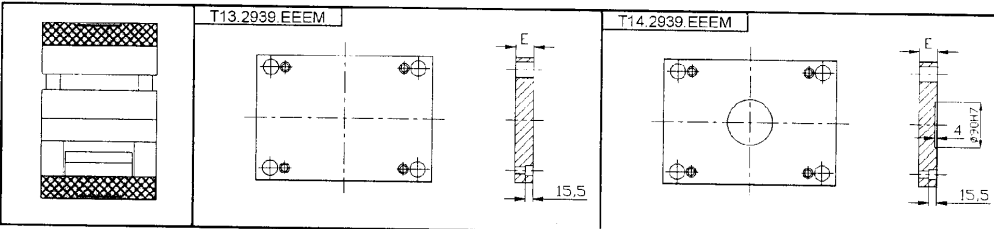

M	A	B	C	D	E
E	1730	2312	2311	2767	2162
22					
27					

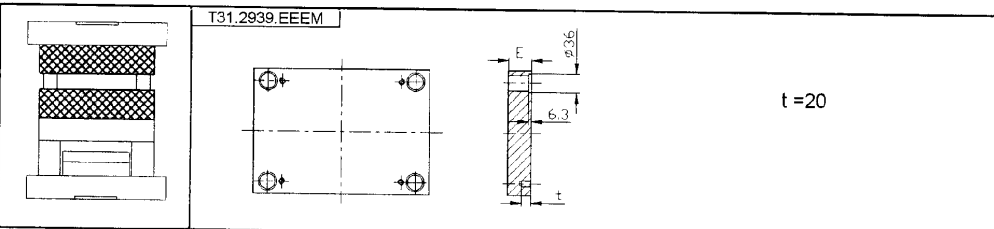

M	A	B	C	D	E
E	1730	2312	2311	2767	2162
27					
36					
46					
56					
66					
76					
86					
96					
116					

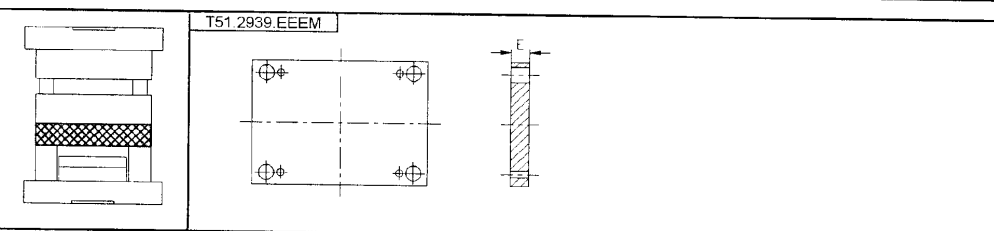

M	A	B	C	D	E
E	1730	2312	2311	2767	2162
36					
46					

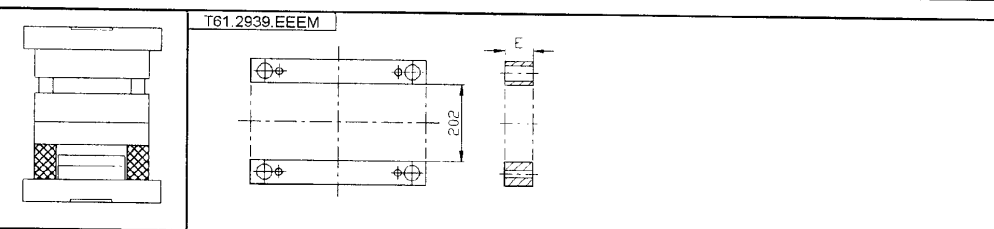

M	A	B	C	D	E
E	1730	2312	2311	2767	2162
56					
76					
96					

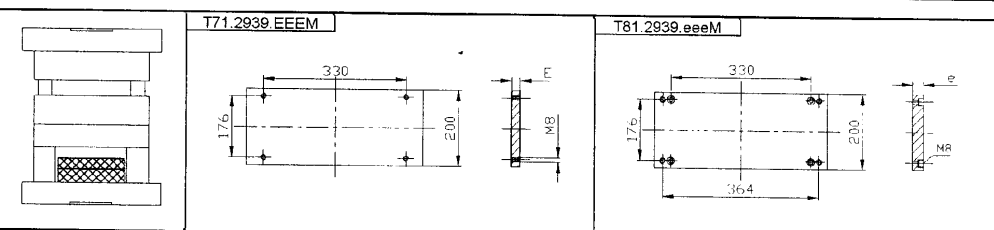

M	A	B	C	D	E
E	1730	2312	2311	2767	2162
17					

M	A	B	C	D	E
e	1730	2312	2311	2767	2162
22					

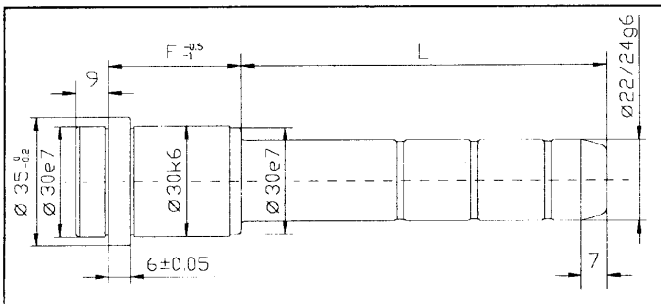
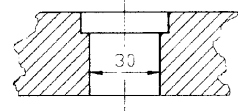

J.22.FFF.LLL / J.24.FFF.LLL					
F	L	Nr ø/Ø	F	L	Nr ø/Ø
27	45	J 22/24.027.045	66	55	J 22/24.066.055
	65	J 22/24.027.065		75	J 22/24.066.075
	105	J 22/24.027.105		95	J 22/24.066.095
36	55	J 22/24.036.055	76	135	J 22/24.076.135
	75	J 22/24.036.075		155	J 22/24.076.155
	105	J 22/24.036.105		195	J 22/24.076.195
46	135	J 22/24.036.135	86	55	J 22/24.086.055
	165	J 22/24.036.165		75	J 22/24.086.075
	65	J 22/24.046.065		95	J 22/24.086.095
	85	J 22/24.046.085		115	J 22/24.086.115
	105	J 22/24.046.105		145	J 22/24.086.145
56	125	J 22/24.046.125	96	195	J 22/24.086.195
	165	J 22/24.046.165		75	J 22/24.096.075
	205	J 22/24.046.205		95	J 22/24.096.095
	55	J 22/24.056.055		135	J 22/24.096.135
	75	J 22/24.056.075		116	J 22/24.116.075
56	95	J 22/24.056.095	136	95	J 22/24.136.095
	115	J 22/24.056.115		135	J 22/24.136.135
	165	J 22/24.056.165			
	205	J 22/24.056.205			

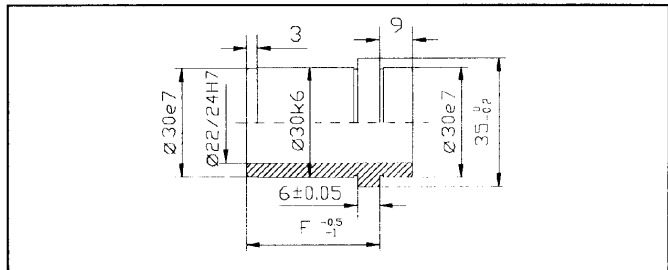

B70.022.OFF / B70.024.OFF			
F	Nr ø/Ø	F	Nr ø/Ø
27	B70.022/24.027	76	B70.022/24.076
36	B70.022/24.036	86	B70.022/24.086
46	B70.022/24.046	96	B70.022/24.096
56	B70.022/24.056	116	B70.022/24.116
66	B70.022/24.066	136	B70.022/24.136

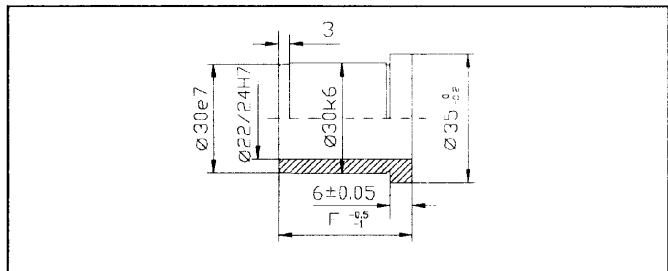

B80.022.OFF / B80.024.OFF			
F	Nr ø/Ø	F	Nr ø/Ø
27	B80.022/24.027	76	B80.022/24.076
36	B80.022/24.036	86	B80.022/24.086
46	B80.022/24.046	96	B80.022/24.096
56	B80.022/24.056	116	B80.022/24.116
66	B80.022/24.066	136	B80.022/24.136

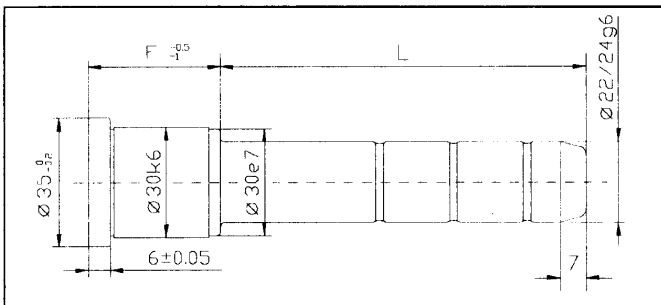

K22.FFF.LLL / K24.FFF.LLL						
F	L	Nr ø/Ø	F	L	Nr ø/Ø	
27	45	K 22/24.027.045	66	55	K 22/24.066.055	
	65	K 22/24.027.065		75	K 22/24.066.075	
	105	K 22/24.027.105		95	K 22/24.066.095	
36	55	K 22/24.036.055	76	135	K 22/24.076.135	
	75	K 22/24.036.075				
	105	K 22/24.036.105				
46	135	K 22/24.036.135	86	55	K 22/24.086.055	
				75	K 22/24.086.075	
	65	K 22/24.046.065		95	K 22/24.086.095	
	85	K 22/24.046.085		115	K 22/24.086.115	
56	105	K 22/24.046.105	96	75	K 22/24.096.075	
	125	K 22/24.046.125		95	K 22/24.096.095	
	55	K 22/24.056.055		135	K 22/24.096.135	
	75	K 22/24.056.075		96	75	K 22/24.096.075
56	95	K 22/24.056.095	116	95	K 22/24.096.095	
	115	K 22/24.056.115		116	75	K 22/24.116.075
					115	K 22/24.116.115
					135	K 22/24.136.135

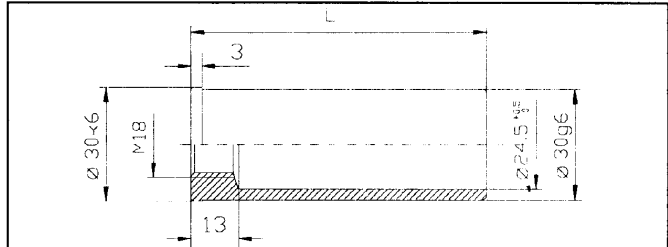

B90.030.LLL			
F	Nr	L	Nr
60	B90.030.060	140	B90.030.140
80	B90.030.080	160	B90.030.160
100	B90.030.100	180	B90.030.180
120	B90.030.120		

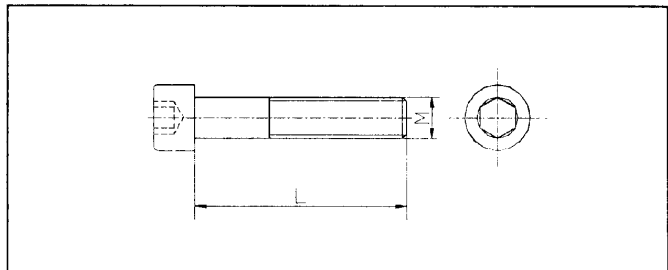

A05.xxx.xxx					
M x L	Nr	M x L	Nr	M x L	Nr
8x25	A05.008.025	12x25	A05.012.025	12x90	A05.012.090
		12x30	A05.012.030	12x100	A05.012.100
		12x35	A05.012.035	12x120	A05.012.120
		12x45	A05.012.045	12x130	A05.012.130
		12x50	A05.012.050	12x140	A05.012.140
		12x55	A05.012.055	12x150	A05.012.150
		12x60	A05.012.060	12x160	A05.012.160
		12x65	A05.012.065	12x180	A05.012.180
		12x70	A05.012.070	12x200	A05.012.200
		12x80	A05.012.080		

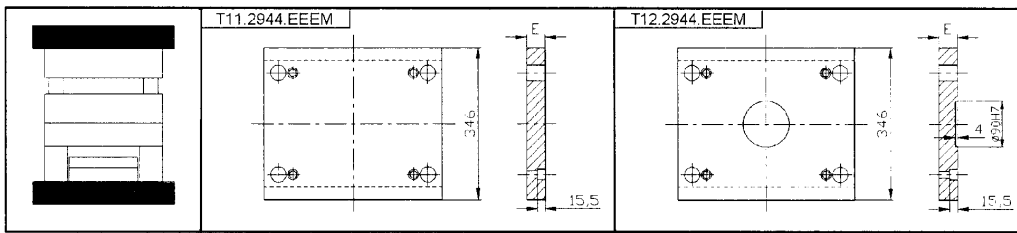
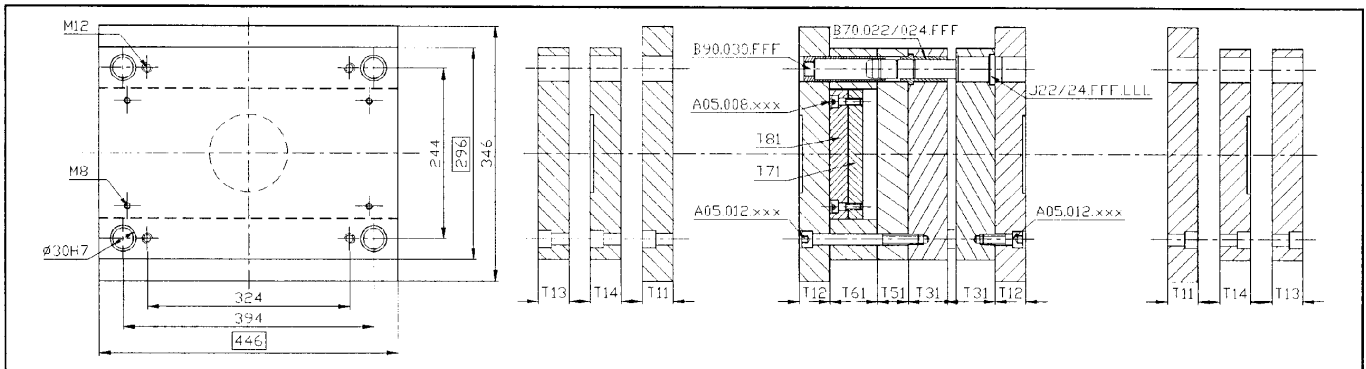

M	A	B	C	D	E
E	1730	2312	2311	2767	2162
36					

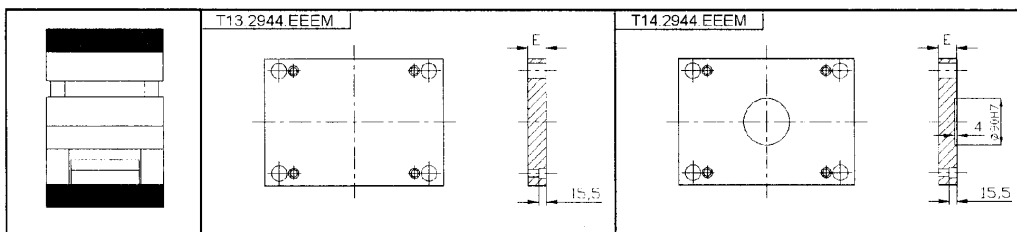

M	A	B	C	D	E
E	1730	2312	2311	2767	2162
27					

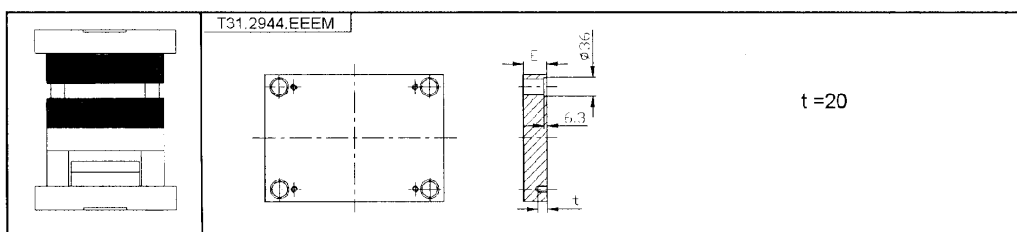

M	A	B	C	D	E
E	1730	2312	2311	2767	2162
27					
36					
46					
56					
66					
76					
86					
96					
116					

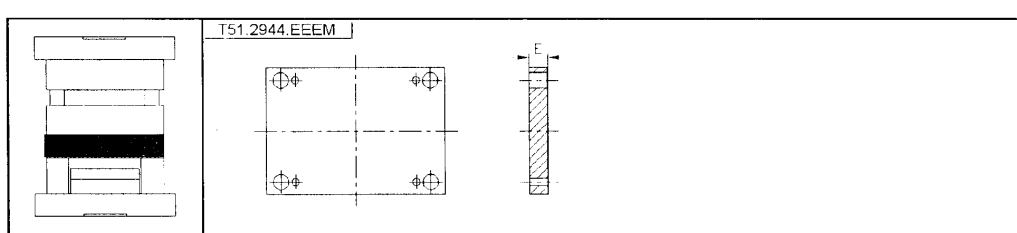

M	A	B	C	D	E
E	1730	2312	2311	2767	2162
36					
46					

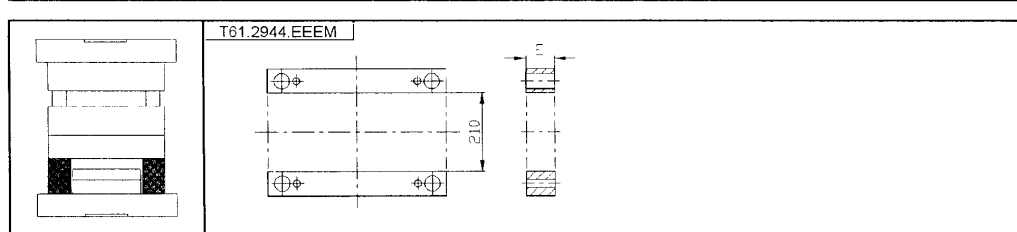

M	A	B	C	D	E
E	1730	2312	2311	2767	2162
56					
76					
96					

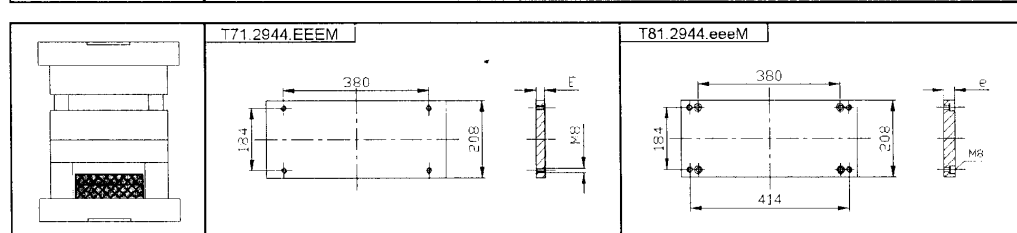

M	A	B	C	D	E
E	1730	2312	2311	2767	2162
17					



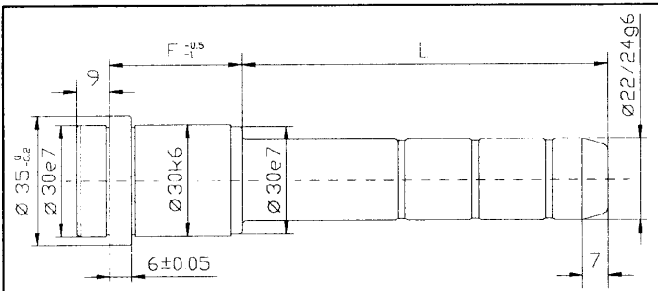
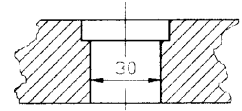

J 22.FFF.LLL / J24.FFF.LLL					
F	L	Nr ø/Ø	F	L	Nr ø/Ø
27	45	J 22/24.027.045	66	55	J 22/24.066.055
	65	J 22/24.027.065		75	J 22/24.066.075
	105	J 22/24.027.105		95	J 22/24.066.095
36	55	J 22/24.036.055	76	135	J 22/24.076.135
	75	J 22/24.036.075		155	J 22/24.066.155
	105	J 22/24.036.105		195	J 22/24.066.195
	135	J 22/24.036.135		55	J 22/24.076.055
46	165	J 22/24.036.165	86	75	J 22/24.076.075
	65	J 22/24.046.065		95	J 22/24.076.095
	85	J 22/24.046.085		115	J 22/24.076.115
	105	J 22/24.046.105		145	J 22/24.076.145
	125	J 22/24.046.125		195	J 22/24.076.195
56	165	J 22/24.046.165	96	75	J 22/24.086.075
	205	J 22/24.046.205		95	J 22/24.086.095
	55	J 22/24.056.055		135	J 22/24.086.135
	75	J 22/24.056.075		75	J 22/24.096.075
	95	J 22/24.056.095		95	J 22/24.096.095
	115	J 22/24.056.115		75	J 22/24.116.075
	165	J 22/24.056.165	116	115	J 22/24.116.115
	205	J 22/24.056.205		95	J 22/24.136.095
				135	J 22/24.136.135

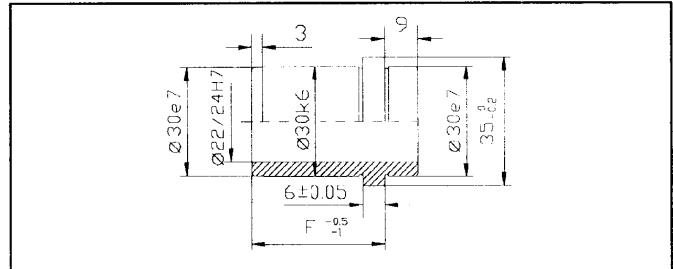

B70.022.OFF / B70.024.OFF			
F	Nr ø/Ø	F	Nr ø/Ø
27	B70.0.22/24.027	76	B70.0.22/24.076
36	B70.0.22/24.036	86	B70.0.22/24.086
46	B70.0.22/24.046	96	B70.0.22/24.096
56	B70.0.22/24.056	116	B70.0.22/24.116
66	B70.0.22/24.066	136	B70.0.22/24.136

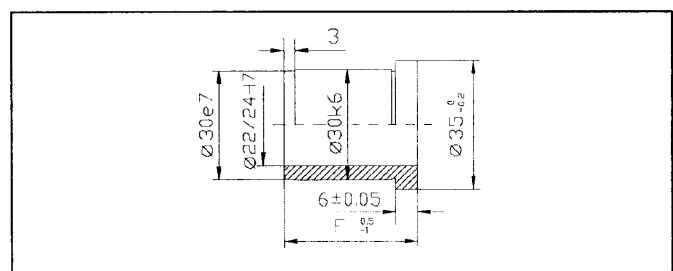

B80.022.OFF / B80.024.OFF			
F	Nr ø/Ø	F	Nr ø/Ø
27	B80.0.22/24.027	76	B80.0.22/24.076
36	B80.0.22/24.036	86	B80.0.22/24.086
46	B80.0.22/24.046	96	B80.0.22/24.096
56	B80.0.22/24.056	116	B80.0.22/24.116
66	B80.0.22/24.066	136	B80.0.22/24.136

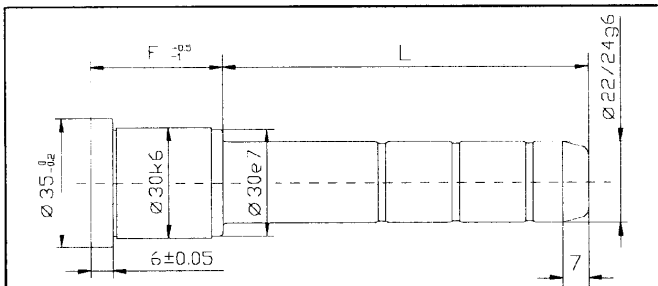

K22.FFF.LLL / K24.FFF.LLL					
F	L	Nr ø/Ø	F	L	Nr ø/Ø
27	45	K 22/24.027.045	66	55	K 22/24.066.055
	65	K 22/24.027.065		75	K 22/24.066.075
	105	K 22/24.027.105		95	K 22/24.066.095
36	55	K 22/24.036.055	76	135	K 22/24.076.135
	75	K 22/24.036.075			
	105	K 22/24.036.105			
	135	K 22/24.036.135			
46	65	K 22/24.046.065	86	55	K 22/24.076.055
	85	K 22/24.046.085		75	K 22/24.076.075
	105	K 22/24.046.105		95	K 22/24.076.095
	125	K 22/24.046.125		115	K 22/24.076.115
				75	K 22/24.086.075
56			96	95	K 22/24.086.095
	55	K 22/24.056.055		135	K 22/24.086.135
	75	K 22/24.056.075		75	K 22/24.096.075
	95	K 22/24.056.095		95	K 22/24.096.095
	115	K 22/24.056.115		75	K 22/24.116.075
				115	K 22/24.116.115
		136	135	K 22/24.136.135	

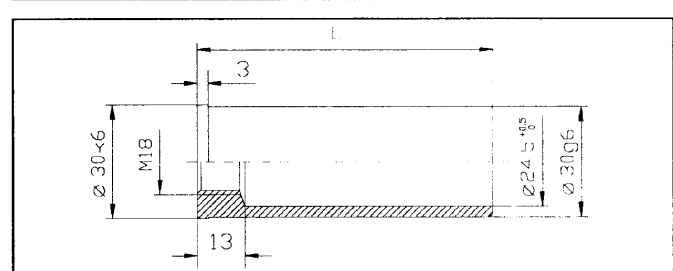

B90.030.LLL			
F	Nr	L	Nr
60	B90.030.060	140	B90.030.140
80	B90.030.080	160	B90.030.160
100	B90.030.100	180	B90.030.180
120	B90.030.120		

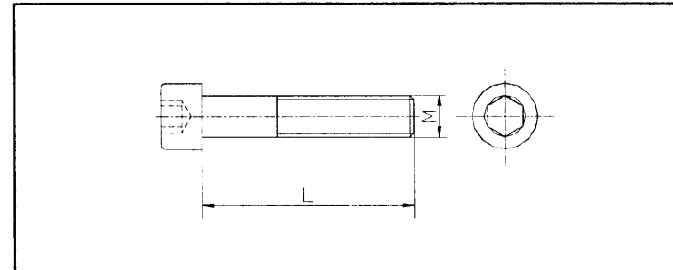

A05.xxx.xxx					
M x L	Nr	M x L	Nr	M x L	Nr
8x25	A05.008.025	12x25	A05.012.025	12x90	A05.012.090
		12x30	A05.012.030	12x100	A05.012.100
		12x35	A05.012.035	12x120	A05.012.120
		12x45	A05.012.045	12x130	A05.012.130
		12x50	A05.012.050	12x140	A05.012.140
		12x55	A05.012.055	12x150	A05.012.150
		12x60	A05.012.060	12x160	A05.012.160
		12x65	A05.012.065	12x180	A05.012.180
		12x70	A05.012.070	12x200	A05.012.200
		12x80	A05.012.080		

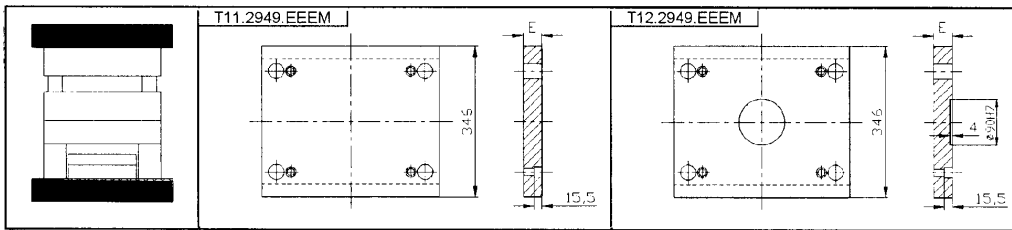
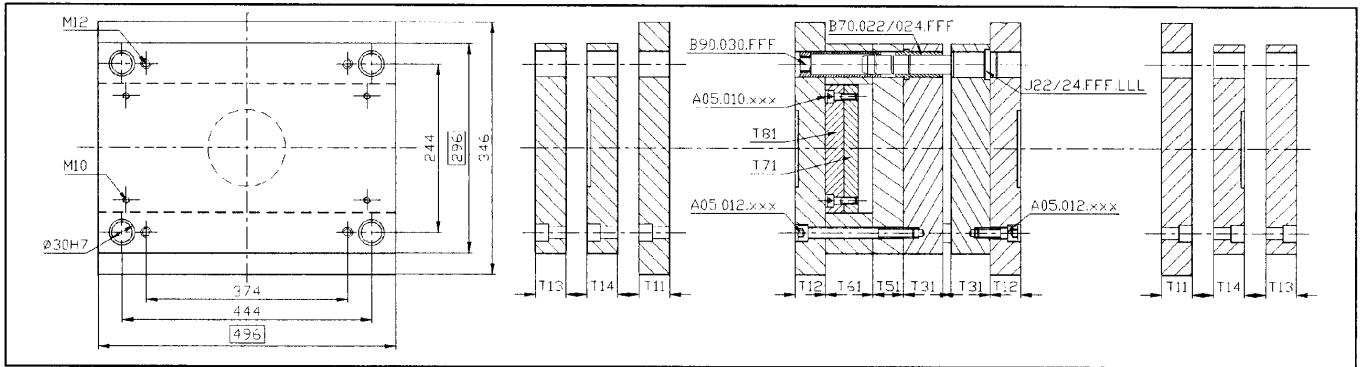

M	A	B	C	D	E
E	1730	2312	2311	2767	2162
36					

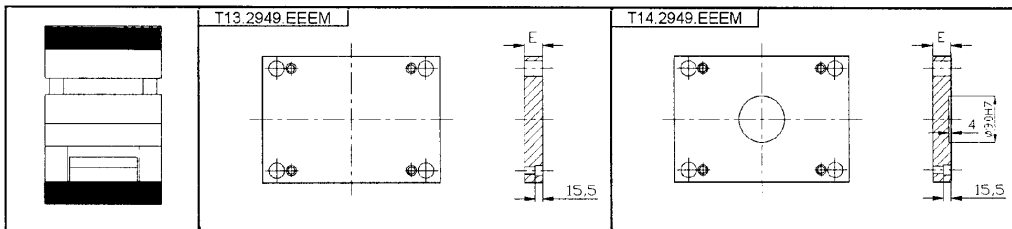

M	A	B	C	D	E
E	1730	2312	2311	2767	2162
27					

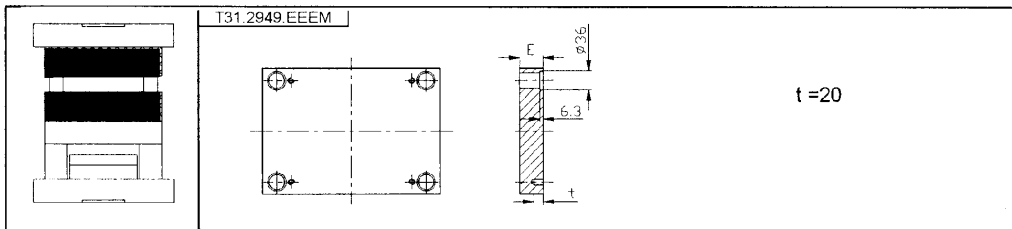

M	A	B	C	D	E
E	1730	2312	2311	2767	2162
27					
36					
46					
56					
66					
76					
86					
96					
116					

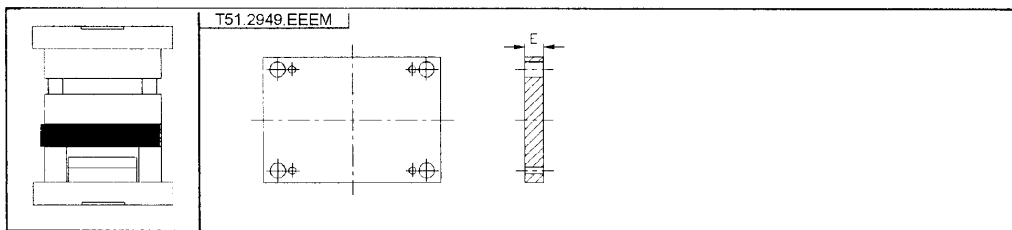

M	A	B	C	D	E
E	1730	2312	2311	2767	2162
36					
46					

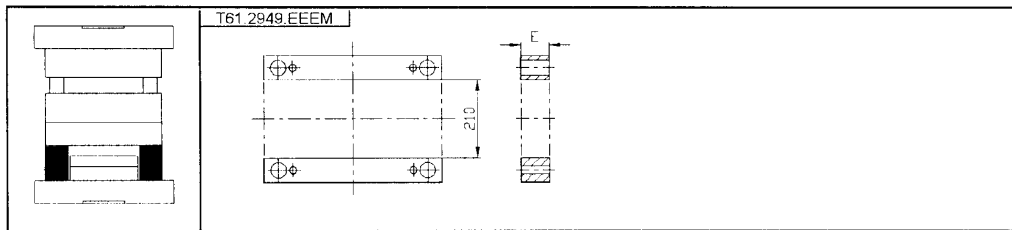

M	A	B	C	D	E
E	1730	2312	2311	2767	2162
56					
76					
96					

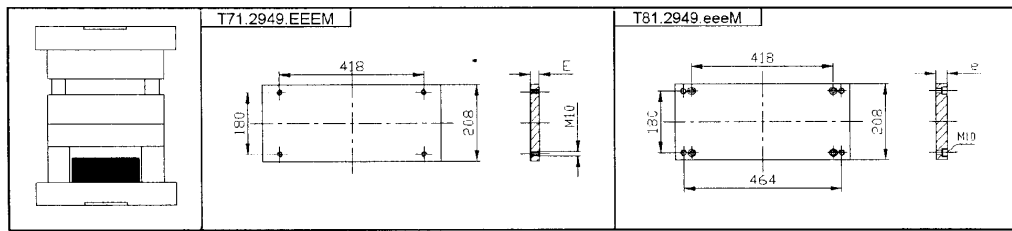

M	A	B	C	D	E
E	1730	2312	2311	2767	2162
17					

e	M	A	B	C	D	E
22						



Ø 22 / Ø 24

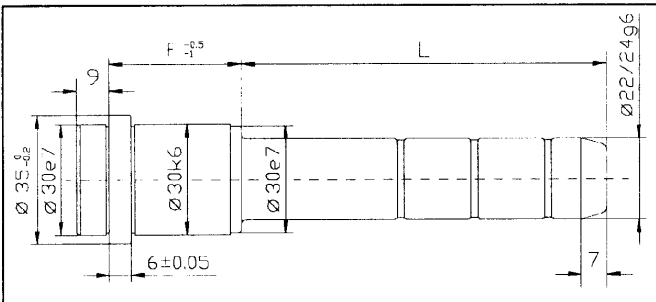
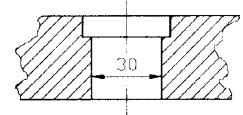

J.22.FFF.LLL / J.24.FFF.LLL					
F	L	Nr ø/Ø	F	L	Nr ø/Ø
27	45	J 22 / 24 .027.045	66	55	J 22 / 24 .066.055
	65	J 22 / 24 .027.065		75	J 22 / 24 .066.075
	105	J 22 / 24 .027.105		95	J 22 / 24 .066.095
36	55	J 22 / 24 .036.055	76	135	J 22 / 24 .076.135
	75	J 22 / 24 .036.075		155	J 22 / 24 .076.155
	105	J 22 / 24 .036.105		195	J 22 / 24 .076.195
	135	J 22 / 24 .036.135		55	J 22 / 24 .076.055
46	65	J 22 / 24 .046.065	86	75	J 22 / 24 .086.075
	85	J 22 / 24 .046.085		95	J 22 / 24 .086.095
	105	J 22 / 24 .046.105		115	J 22 / 24 .086.115
	125	J 22 / 24 .046.125		145	J 22 / 24 .086.145
	165	J 22 / 24 .046.165		195	J 22 / 24 .086.195
56	205	J 22 / 24 .056.205	96	75	J 22 / 24 .096.075
	55	J 22 / 24 .056.055		95	J 22 / 24 .096.095
	75	J 22 / 24 .056.075		135	J 22 / 24 .096.135
	95	J 22 / 24 .056.095		116	J 22 / 24 .116.075
	115	J 22 / 24 .056.115		115	J 22 / 24 .116.115
	165	J 22 / 24 .056.165	136	95	J 22 / 24 .136.095
	205	J 22 / 24 .056.205		135	J 22 / 24 .136.135

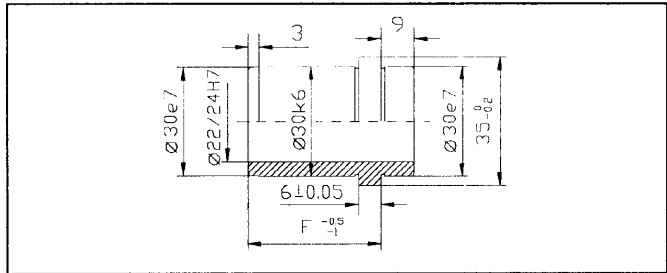

B70.022.OFF / B70.024.OFF			
F	Nr ø/Ø	F	Nr ø/Ø
27	B70.0 22 / 24 .027	76	B70.0 22 / 24 .076
36	B70.0 22 / 24 .036	86	B70.0 22 / 24 .086
46	B70.0 22 / 24 .046	96	B70.0 22 / 24 .096
56	B70.0 22 / 24 .056	116	B70.0 22 / 24 .116
66	B70.0 22 / 24 .066	136	B70.0 22 / 24 .136

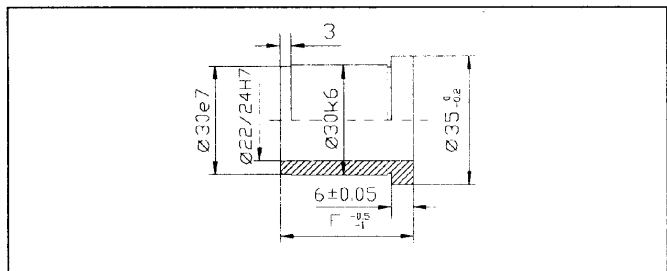

B80.022.OFF / B80.024.OFF			
F	Nr ø/Ø	F	Nr ø/Ø
27	B80.0 22 / 24 .027	76	B80.0 22 / 24 .076
36	B80.0 22 / 24 .036	86	B80.0 22 / 24 .086
46	B80.0 22 / 24 .046	96	B80.0 22 / 24 .096
56	B80.0 22 / 24 .056	116	B80.0 22 / 24 .116
66	B80.0 22 / 24 .066	136	B80.0 22 / 24 .136

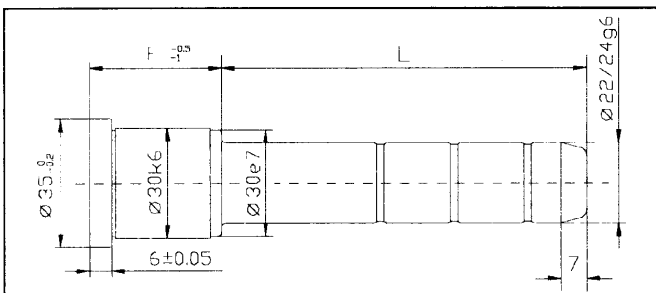

K22.FFF.LLL / K24.FFF.LLL						
F	L	Nr ø/Ø	F	L	Nr ø/Ø	
27	45	K 22 / 24 .027.045	66	55	K 22 / 24 .066.055	
	65	K 22 / 24 .027.065		75	K 22 / 24 .066.075	
	105	K 22 / 24 .027.105		95	K 22 / 24 .066.095	
36	55	K 22 / 24 .036.055	76	135	K 22 / 24 .076.135	
	75	K 22 / 24 .036.075				
	105	K 22 / 24 .036.105				
	135	K 22 / 24 .036.135				
46	65	K 22 / 24 .046.065	86	55	K 22 / 24 .076.055	
	85	K 22 / 24 .046.085		75	K 22 / 24 .076.075	
	105	K 22 / 24 .046.105		95	K 22 / 24 .076.095	
	125	K 22 / 24 .046.125		115	K 22 / 24 .076.115	
				75	K 22 / 24 .086.075	
56	55	K 22 / 24 .056.055	96	95	K 22 / 24 .086.095	
	75	K 22 / 24 .056.075		135	K 22 / 24 .086.135	
	95	K 22 / 24 .056.095		96	75	K 22 / 24 .096.075
	115	K 22 / 24 .056.115		95	95	K 22 / 24 .096.095
				116	75	K 22 / 24 .116.075
			115	K 22 / 24 .116.115		
			136	135	K 22 / 24 .136.135	

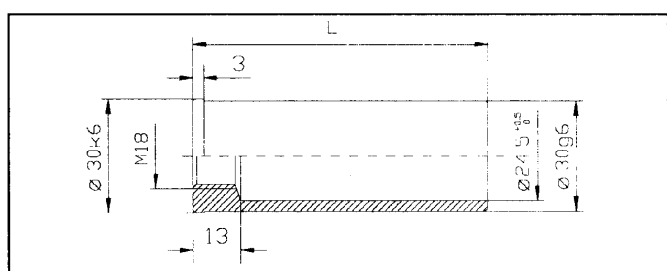

B90.030.LLL			
F	Nr	L	Nr
60	B90.030.060	140	B90.030.140
80	B90.030.080	160	B90.030.160
100	B90.030.100	180	B90.030.180
120	B90.030.120		

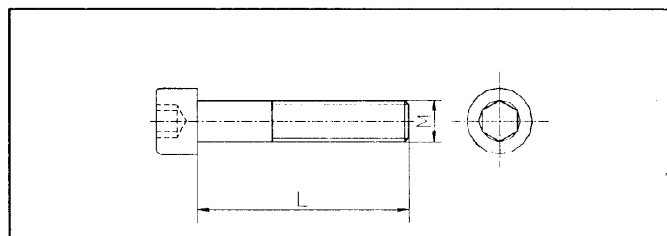

A05.xxx.xxx					
M x L	Nr	M x L	Nr	M x L	Nr
10x25	A05.010.025	12x25	A05.012.025	12x90	A05.012.090
		12x30	A05.012.030	12x100	A05.012.100
		12x35	A05.012.035	12x120	A05.012.120
		12x45	A05.012.045	12x130	A05.012.130
		12x50	A05.012.050	12x140	A05.012.140
		12x55	A05.012.055	12x150	A05.012.150
		12x60	A05.012.060	12x160	A05.012.160
		12x65	A05.012.065	12x180	A05.012.180
		12x70	A05.012.070	12x200	A05.012.200
		12x80	A05.012.080		

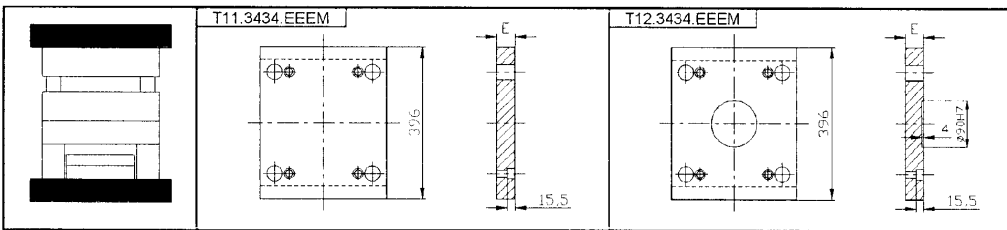
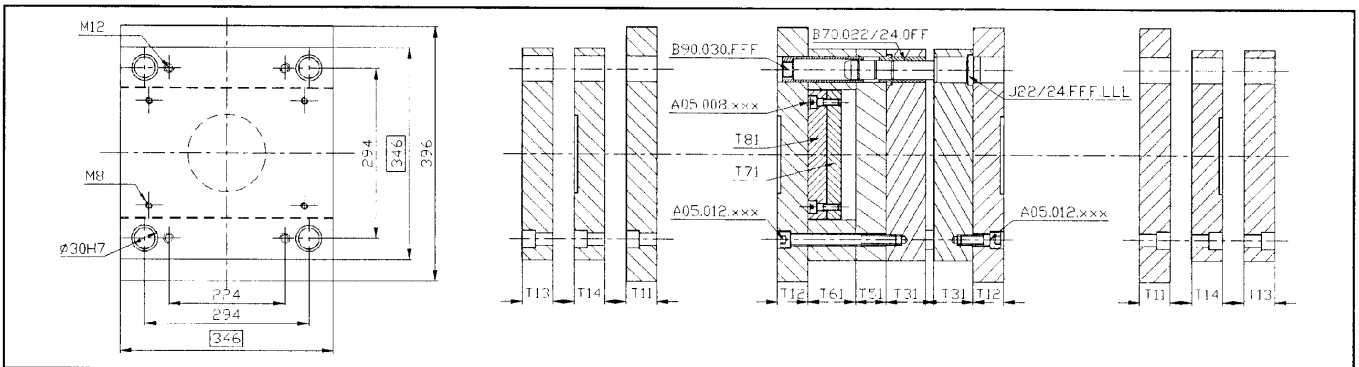

M	A	B	C	D	E
27	1730	2312	2311	2767	2162
36					

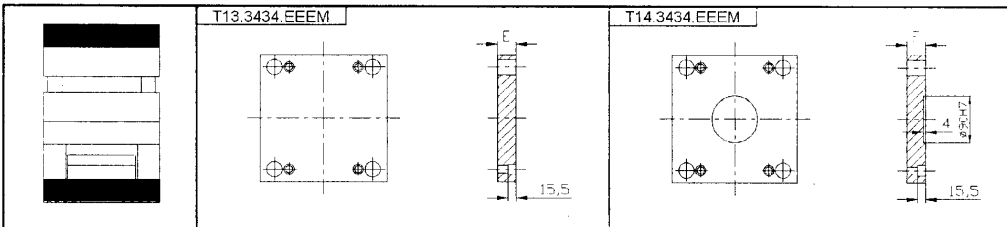

M	A	B	C	D	E
22	1730	2312	2311	2767	2162
27					

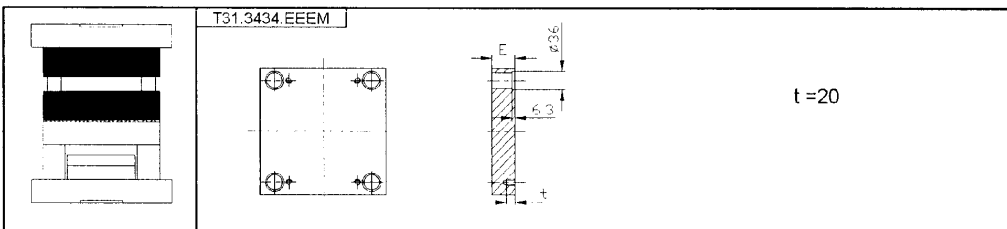

M	A	B	C	D	E
27	1730	2312	2311	2767	2162
36					
46					
56					
66					
76					
86					
96					
116					

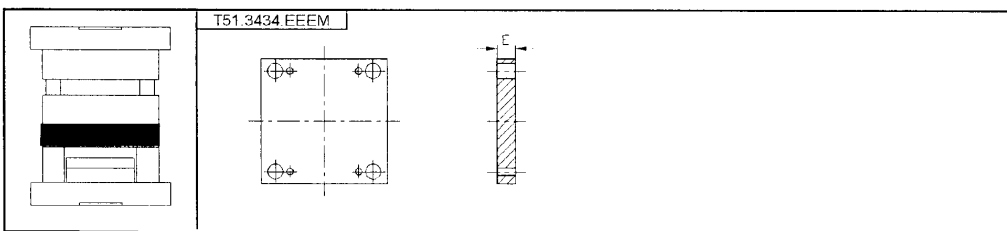

M	A	B	C	D	E
36	1730	2312	2311	2767	2162
46					

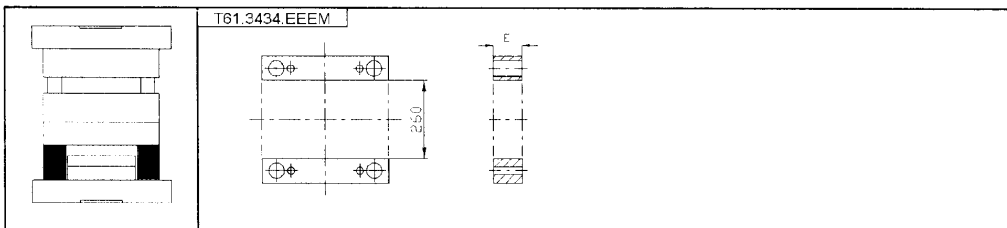

M	A	B	C	D	E
56	1730	2312	2311	2767	2162
76					
96					

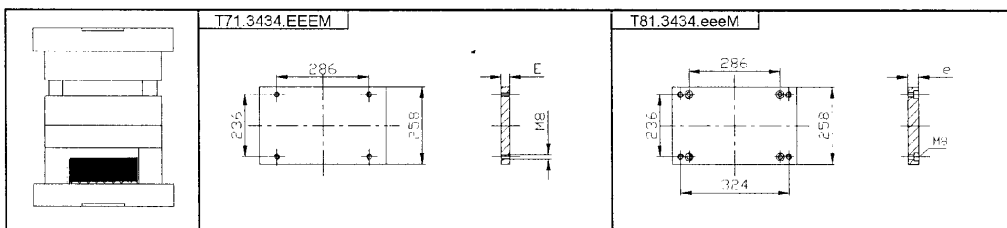

M	A	B	C	D	E
17	1730	2312	2311	2767	2162



Ø 22 / Ø 24

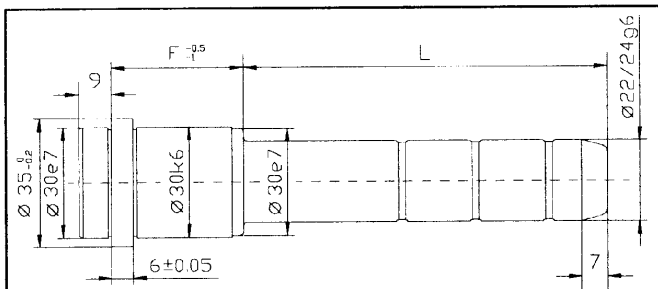
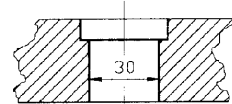

J.22.FFF.LLL / J.24.FFF.LLL						
F	L	Nr ø / Ø	F	L	Nr ø / Ø	
27	45	J 22 / 24 .027.045	66	55	J 22 / 24 .066.055	
	65	J 22 / 24 .027.065		75	J 22 / 24 .066.075	
	105	J 22 / 24 .027.105		95	J 22 / 24 .066.095	
36	55	J 22 / 24 .036.055	76	135	J 22 / 24 .066.135	
	75	J 22 / 24 .036.075		155	J 22 / 24 .066.155	
	105	J 22 / 24 .036.105		195	J 22 / 24 .066.195	
	135	J 22 / 24 .036.135		55	J 22 / 24 .076.055	
46	165	J 22 / 24 .036.165	86	75	J 22 / 24 .076.075	
	65	J 22 / 24 .046.065		95	J 22 / 24 .076.095	
	85	J 22 / 24 .046.085		115	J 22 / 24 .076.115	
	105	J 22 / 24 .046.105		145	J 22 / 24 .076.145	
	125	J 22 / 24 .046.125		195	J 22 / 24 .076.195	
56	165	J 22 / 24 .046.165	96	75	J 22 / 24 .086.075	
	205	J 22 / 24 .046.205		95	J 22 / 24 .086.095	
	55	J 22 / 24 .056.055		135	J 22 / 24 .086.135	
	75	J 22 / 24 .056.075		75	J 22 / 24 .096.075	
	95	J 22 / 24 .056.095		95	J 22 / 24 .096.095	
	115	J 22 / 24 .056.115		116	75	J 22 / 24 .116.075
	165	J 22 / 24 .056.165		115	J 22 / 24 .116.115	
	205	J 22 / 24 .056.205		136	95	J 22 / 24 .136.095
				135	J 22 / 24 .136.135	

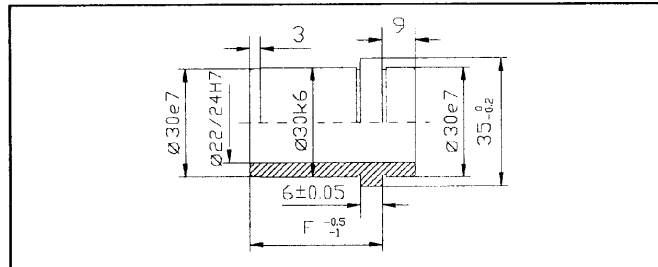

B70.022.OFF / B70.024.OFF			
F	Nr ø / Ø	F	Nr ø / Ø
27	B70.0 22 / 24 .027	76	B70.0 22 / 24 .076
36	B70.0 22 / 24 .036	86	B70.0 22 / 24 .086
46	B70.0 22 / 24 .046	96	B70.0 22 / 24 .096
56	B70.0 22 / 24 .056	116	B70.0 22 / 24 .116
66	B70.0 22 / 24 .066	136	B70.0 22 / 24 .136

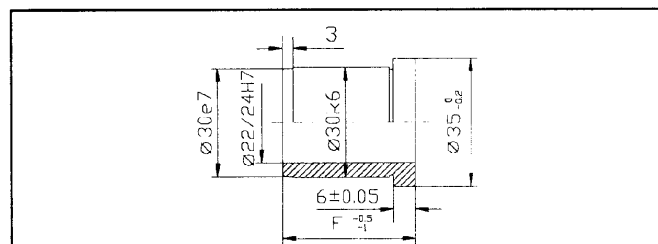

B80.022.OFF / B80.024.OFF			
F	Nr ø / Ø	F	Nr ø / Ø
27	B80.0 22 / 24 .027	76	B80.0 22 / 24 .076
36	B80.0 22 / 24 .036	86	B80.0 22 / 24 .086
46	B80.0 22 / 24 .046	96	B80.0 22 / 24 .096
56	B80.0 22 / 24 .056	116	B80.0 22 / 24 .116
66	B80.0 22 / 24 .066	136	B80.0 22 / 24 .136

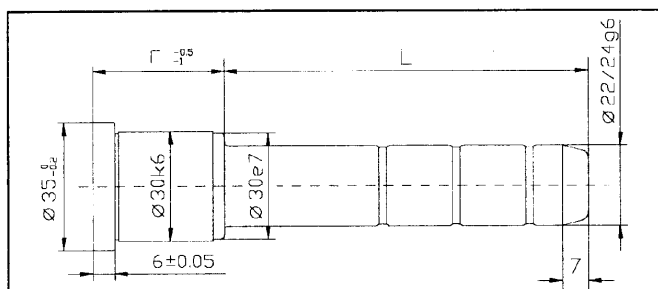

K.22.FFF.LLL / K.24.FFF.LLL					
F	L	Nr ø / Ø	F	L	Nr ø / Ø
27	45	K 22 / 24 .027.045	66	55	K 22 / 24 .066.055
	65	K 22 / 24 .027.065		75	K 22 / 24 .066.075
	105	K 22 / 24 .027.105		95	K 22 / 24 .066.095
36	55	K 22 / 24 .036.055	76	135	K 22 / 24 .066.135
	75	K 22 / 24 .036.075			
	105	K 22 / 24 .036.105			
	135	K 22 / 24 .036.135			
46	65	K 22 / 24 .046.065	86	55	K 22 / 24 .076.055
	85	K 22 / 24 .046.085		75	K 22 / 24 .076.075
	105	K 22 / 24 .046.105		95	K 22 / 24 .076.095
	125	K 22 / 24 .046.125		115	K 22 / 24 .076.115
56			96	75	K 22 / 24 .086.075
	55	K 22 / 24 .056.055		95	K 22 / 24 .086.095
	75	K 22 / 24 .056.075		135	K 22 / 24 .086.135
	95	K 22 / 24 .056.095		75	K 22 / 24 .096.075
	115	K 22 / 24 .056.115		95	K 22 / 24 .096.095
				116	75
			115	K 22 / 24 .116.115	
			136	135	K 22 / 24 .136.135

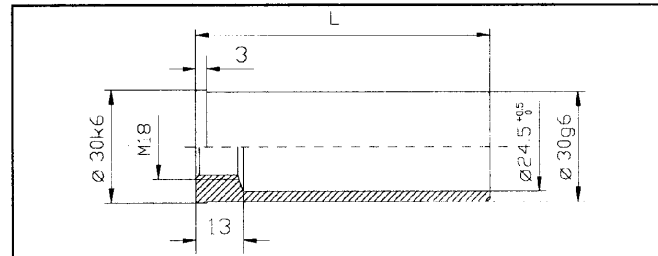

B90.030.LLL			
F	Nr	L	Nr
60	B90.030.060	140	B90.030.140
80	B90.030.080	160	B90.030.160
100	B90.030.100	180	B90.030.180
120	B90.030.120		

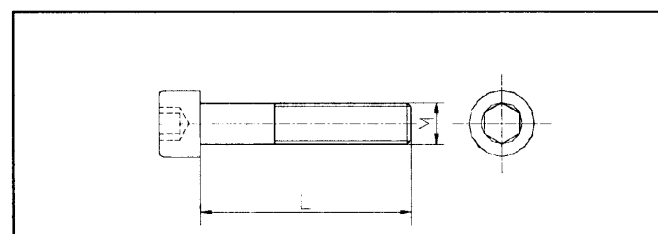

A05.xxx.xxx					
M x L	Nr	M x L	Nr	M x L	Nr
8x25	A05.008.025	12x25	A05.012.025	12x90	A05.012.090
		12x30	A05.012.030	12x100	A05.012.100
		12x35	A05.012.035	12x120	A05.012.120
		12x45	A05.012.045	12x130	A05.012.130
		12x50	A05.012.050	12x140	A05.012.140
		12x55	A05.012.055	12x150	A05.012.150
		12x60	A05.012.060	12x160	A05.012.160
		12x65	A05.012.065	12x180	A05.012.180
		12x70	A05.012.070	12x200	A05.012.200
		12x80	A05.012.080		

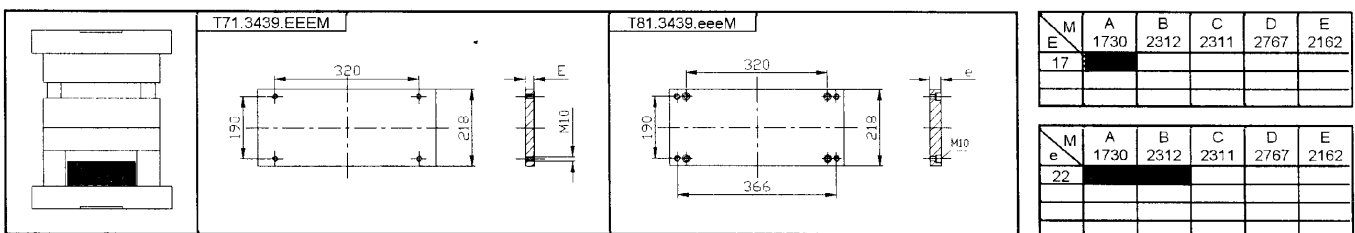
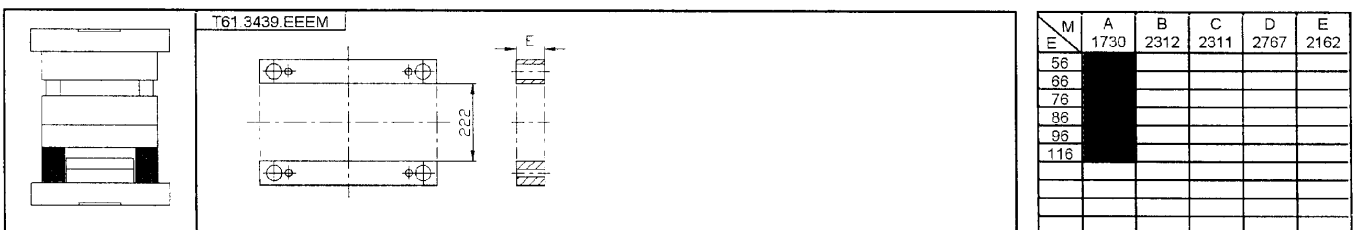
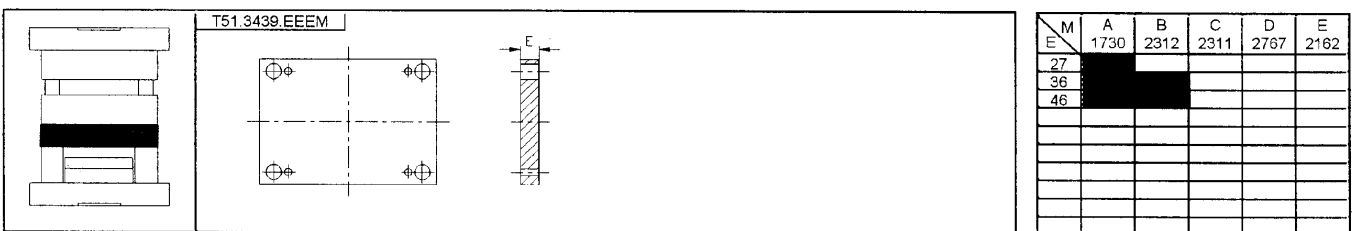
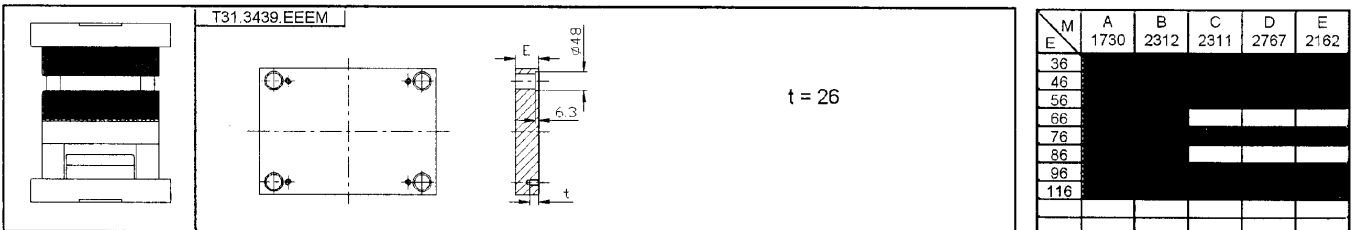
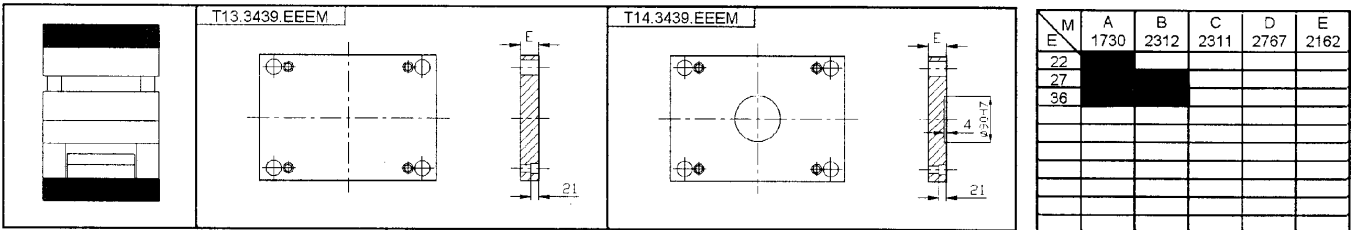
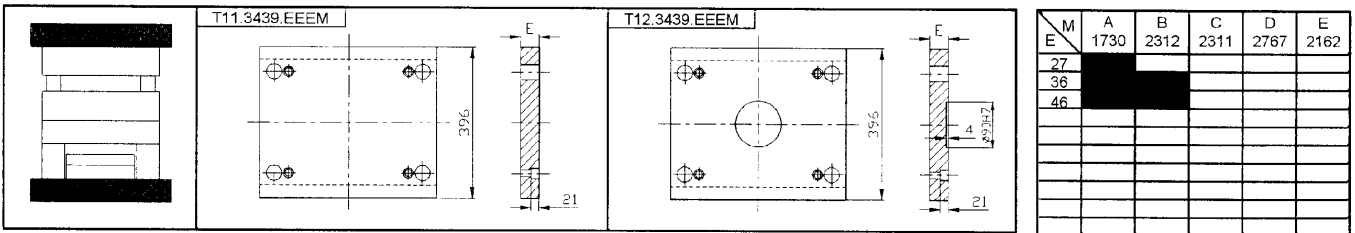
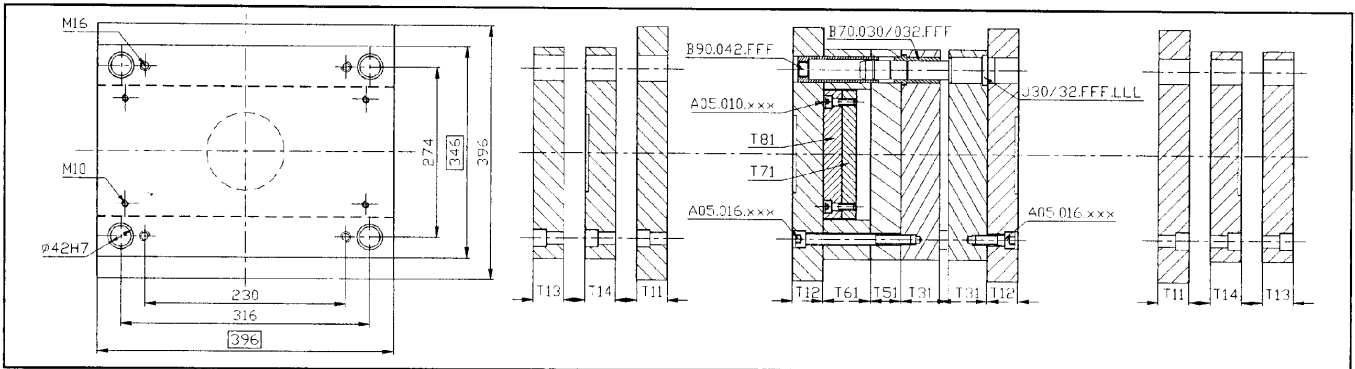



Ø 30 / Ø 32

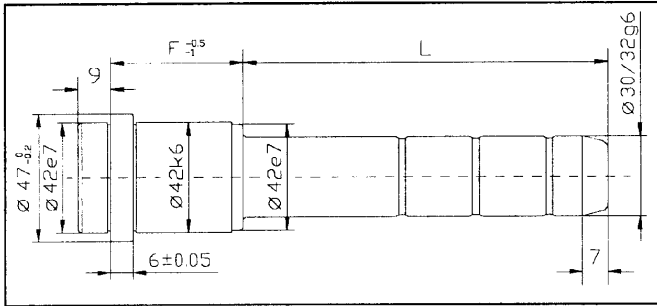
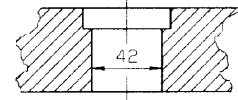

J30.FFF.LLL / J32.FFF.LLL

F	L	Nr ø/Ø	F	L	Nr ø/Ø	
36	55	J 30 / 32 036.055	76	55	J 30 / 32 076.055	
	75	J 30 / 32 036.075		75	J 30 / 32 076.075	
	95	J 30 / 32 036.095		95	J 30 / 32 076.095	
46	45	J 30 / 32 046.045	76	115	J 30 / 32 076.115	
	65	J 30 / 32 046.065		155	J 30 / 32 076.155	
	105	J 30 / 32 046.105		225	J 30 / 32 076.225	
	125	J 30 / 32 046.125		75	J 30 / 32 086.075	
	165	J 30 / 32 046.165		115	J 30 / 32 086.115	
56	245	J 30 / 32 046.245	86	155	J 30 / 32 086.155	
	55	J 30 / 32 056.055		96	75	J 30 / 32 096.075
	75	J 30 / 32 056.075			105	J 30 / 32 096.105
	105	J 30 / 32 056.105			75	J 30 / 32 116.075
	135	J 30 / 32 056.135			115	J 30 / 32 116.115
66	175	J 30 / 32 056.175	116		95	J 30 / 32 136.095
	245	J 30 / 32 056.245		115	J 30 / 32 136.115	
	55	J 30 / 32 066.055		156	115	J 30 / 32 156.115
	75	J 30 / 32 066.075			155	J 30 / 32 156.155
	95	J 30 / 32 066.095				
135	J 30 / 32 066.135					
175	J 30 / 32 066.175					
245	J 30 / 32 066.245					

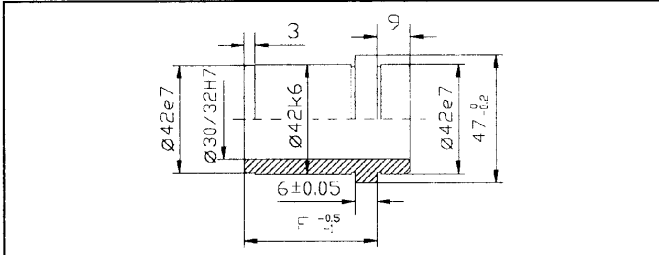

B70.030.OFF / B70.032.OFF

F	Nr ø/Ø	F	Nr ø/Ø
36	B70.030/32.036	86	B70.030/32.086
46	B70.030/32.046	96	B70.030/32.096
56	B70.030/32.056	116	B70.030/32.116
66	B70.030/32.066	136	B70.030/32.136
76	B70.030/32.076	156	B70.030/32.156

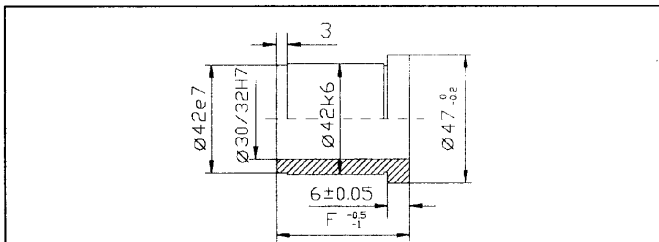

B80.030.OFF / B80.032.OFF

F	Nr ø/Ø	F	Nr ø/Ø
36	B80.030/32.036	86	B80.030/32.086
46	B80.030/32.046	96	B80.030/32.096
56	B80.030/32.056	116	B80.030/32.116
66	B80.030/32.066	136	B80.030/32.136
76	B80.030/32.076	156	B80.030/32.156

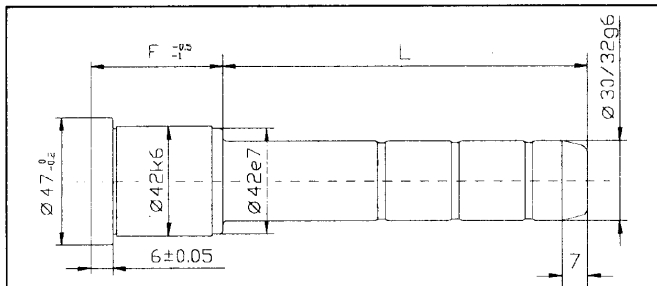

K30.FFF.LLL / K32.FFF.LLL

F	L	Nr ø/Ø	F	L	Nr ø/Ø		
36	55	K 30 / 32 036.055	76	55	K 30 / 32 076.055		
	75	K 30 / 32 036.075		75	K 30 / 32 076.075		
	105	K 30 / 32 036.105		95	K 30 / 32 076.095		
46	45	K 30 / 32 046.045	76	115	K 30 / 32 076.115		
	65	K 30 / 32 046.065					
	105	K 30 / 32 046.105		86	75	K 30 / 32 086.075	
	125	K 30 / 32 046.125			95	K 30 / 32 086.095	
	165	K 30 / 32 046.165					
56	55	K 30 / 32 056.055	96		75	K 30 / 32 096.075	
	75	K 30 / 32 056.075			105	K 30 / 32 096.105	
	105	K 30 / 32 056.105		116	75	K 30 / 32 116.075	
	135	K 30 / 32 056.135			115	K 30 / 32 116.105	
	175	K 30 / 32 056.175			136	95	K 30 / 32 136.095
66	55	K 30 / 32 066.055	156			115	K 30 / 32 136.115
	75	K 30 / 32 066.075				115	K 30 / 32 156.115
	105	K 30 / 32 066.105					
	135	K 30 / 32 066.135					
	175	K 30 / 32 066.175					

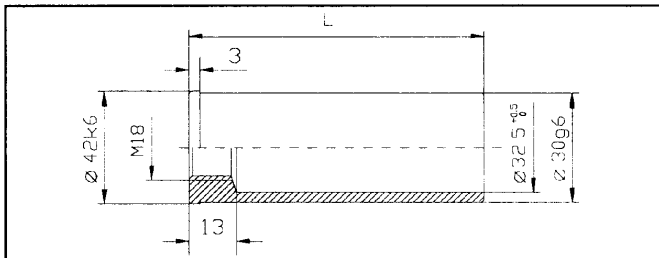

B90.042.LLL

L	Nr	L	Nr
60	B90.042.060	140	B90.042.140
100	B90.042.100	160	B90.042.160
120	B90.042.120	180	B90.042.180

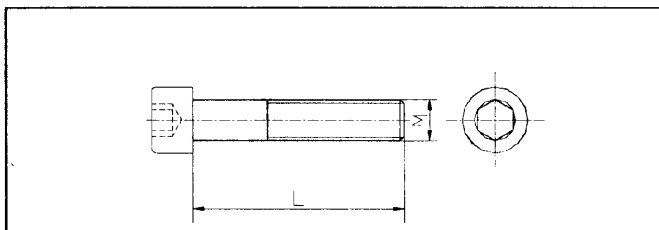

A05xxx xxx

M x L	Nr	M x L	Nr	M x L	Nr
10x25	A05.010.025	16x80	A05.016.060	16x140	A05.016.140
		16x85	A05.016.065	16x150	A05.016.150
		16x70	A05.016.070	16x180	A05.016.180
		16x80	A05.016.080	16x180	A05.016.180
16x30	A05.016.030	16x90	A05.016.090	16x200	A05.016.200
16x35	A05.016.035	16x100	A05.016.100	16x210	A05.016.210
16x45	A05.016.045	16x120	A05.016.120	16x220	A05.016.220
16x55	A05.016.055	16x130	A05.016.130	16x230	A05.016.230

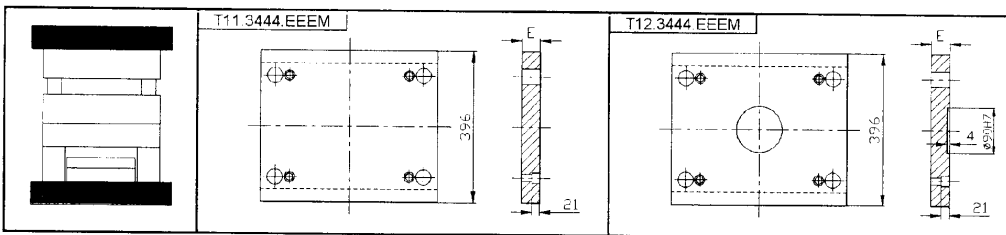
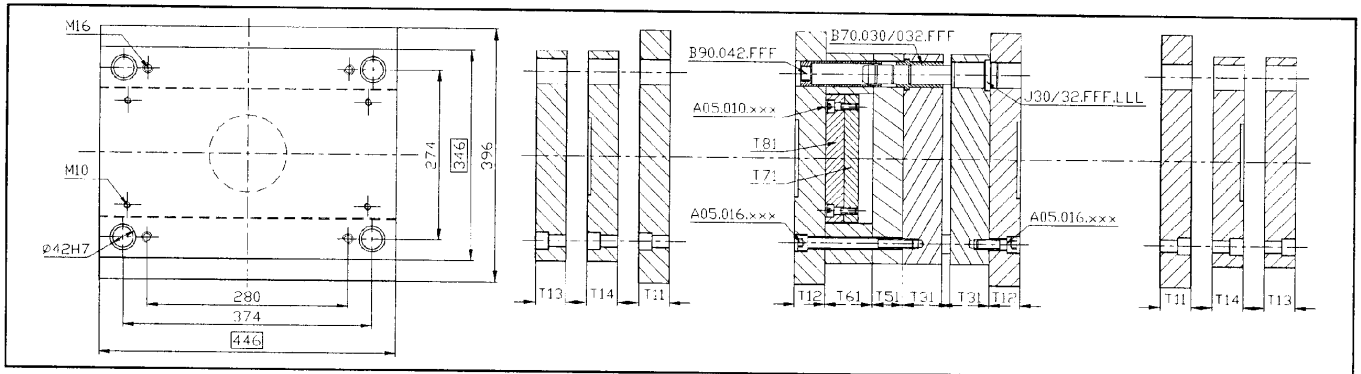

M	A	B	C	D	E
E	1730	2312	2311	2767	2162
27					
36					
46					

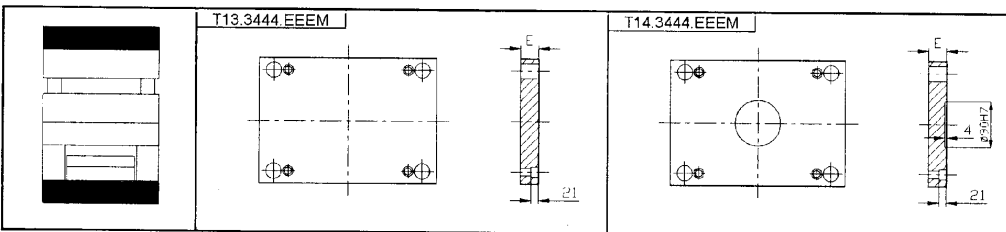

M	A	B	C	D	E
E	1730	2312	2311	2767	2162
22					
27					
36					

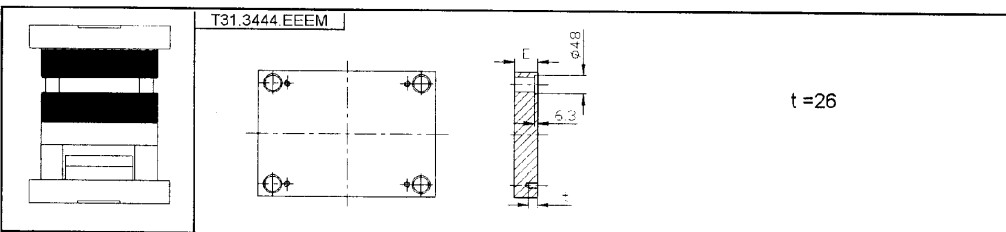

M	A	B	C	D	E
E	1730	2312	2311	2767	2162
36					
46					
56					
66					
76					
86					
96					
116					

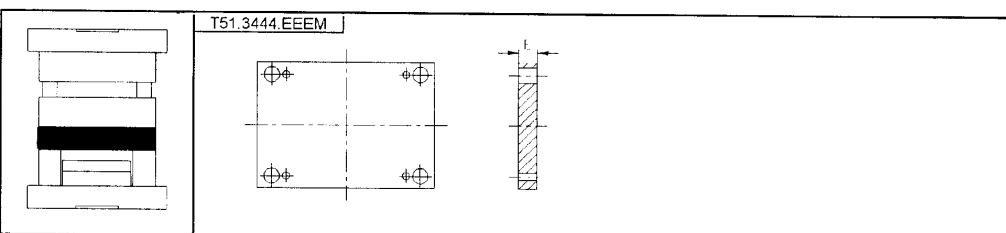

M	A	B	C	D	E
E	1730	2312	2311	2767	2162
27					
36					
46					

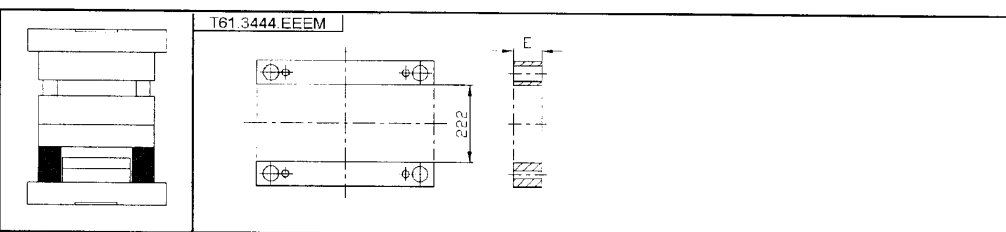

M	A	B	C	D	E
E	1730	2312	2311	2767	2162
56					
66					
76					
86					
96					
116					
136					

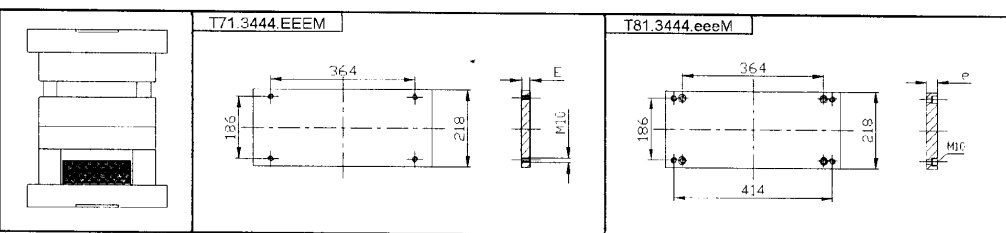

M	A	B	C	D	E
E	1730	2312	2311	2767	2162
17					

  

e	M	A	B	C	D	E
22						





Ø 30 / Ø 32

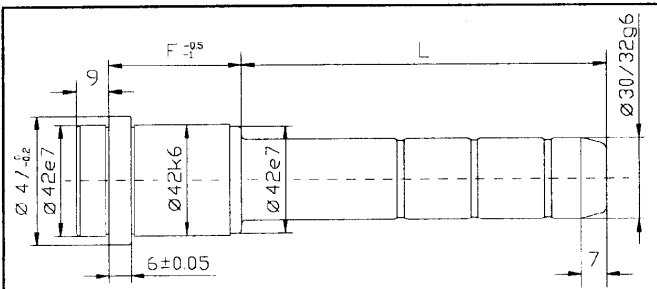
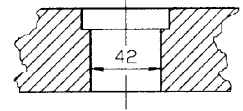

J30.FFF.LLL / J32.FFF.LLL								
F	L	Nr	Ø	F	L	Nr	Ø	
36	55	J 30/32	036.055	76	55	J 30/32	076.055	
	75	J 30/32	036.075		75	J 30/32	076.075	
	95	J 30/32	036.095		95	J 30/32	076.095	
46	45	J 30/32	046.045	86	115	J 30/32	076.115	
	65	J 30/32	046.065		155	J 30/32	076.155	
	105	J 30/32	046.105		225	J 30/32	076.225	
	125	J 30/32	046.125		75	J 30/32	086.075	
	165	J 30/32	046.165		115	J 30/32	086.115	
56	245	J 30/32	046.245	156	155	J 30/32	086.155	
	55	J 30/32	056.055		75	J 30/32	096.075	
	75	J 30/32	056.075		105	J 30/32	096.105	
	105	J 30/32	056.105		116	75	J 30/32	116.075
	135	J 30/32	056.135		115	J 30/32	116.115	
66	175	J 30/32	056.175	136	95	J 30/32	136.095	
	245	J 30/32	056.245		115	J 30/32	136.115	
	55	J 30/32	066.055		115	J 30/32	156.115	
	75	J 30/32	066.075		155	J 30/32	156.155	
	95	J 30/32	066.095					
	135	J 30/32	066.135					
	175	J 30/32	066.175					
	245	J 30/32	066.245					

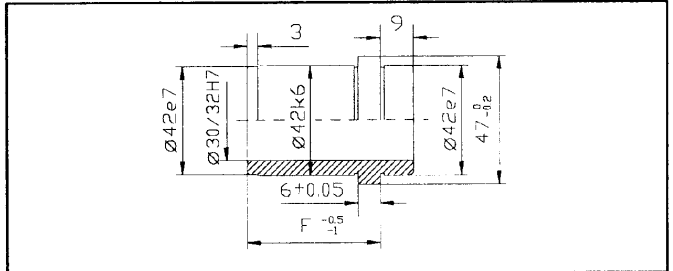

B70.030.OFF / B70.032.OFF					
F	Nr	Ø	F	Nr	Ø
36	B70.030/32	036	86	B70.030/32	086
46	B70.030/32	046	96	B70.030/32	096
56	B70.030/32	056	116	B70.030/32	116
66	B70.030/32	066	136	B70.030/32	136
76	B70.030/32	076	156	B70.030/32	156

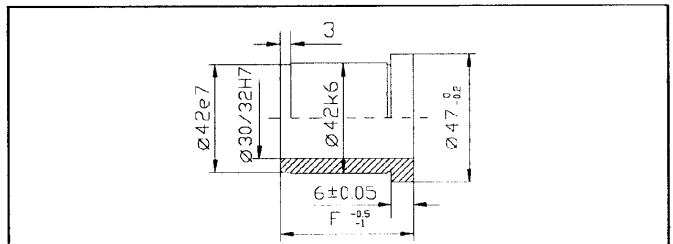

B80.030.OFF / B80.032.OFF					
F	Nr	Ø	F	Nr	Ø
36	B80.030/32	036	86	B80.030/32	086
46	B80.030/32	046	96	B80.030/32	096
56	B80.030/32	056	116	B80.030/32	116
66	B80.030/32	066	136	B80.030/32	136
76	B80.030/32	076	156	B80.030/32	156

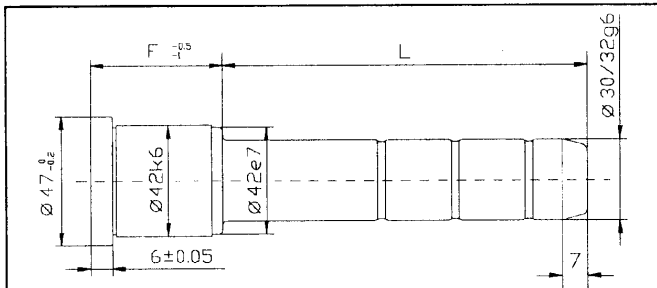

K30.FFF.LLL / K32.FFF.LLL								
F	L	Nr	Ø	F	L	Nr	Ø	
36	55	K 30/32	036.055	76	55	K 30/32	076.055	
	75	K 30/32	036.075		75	K 30/32	076.075	
	105	K 30/32	036.105		95	K 30/32	076.095	
46	45	K 30/32	046.045	86	115	K 30/32	076.115	
	65	K 30/32	046.065		75	K 30/32	086.075	
	105	K 30/32	046.105		95	K 30/32	086.095	
	125	K 30/32	046.125		96	75	K 30/32	096.075
	165	K 30/32	046.165		105	K 30/32	096.105	
56	55	K 30/32	056.055	116	75	K 30/32	116.075	
	75	K 30/32	056.075		115	K 30/32	116.105	
	105	K 30/32	056.105		136	95	K 30/32	136.095
	135	K 30/32	056.135		115	K 30/32	136.115	
	175	K 30/32	056.175		156	115	K 30/32	156.115
66	55	K 30/32	066.055					
	75	K 30/32	066.075					
	105	K 30/32	066.105					
	135	K 30/32	066.135					
	175	K 30/32	066.175					

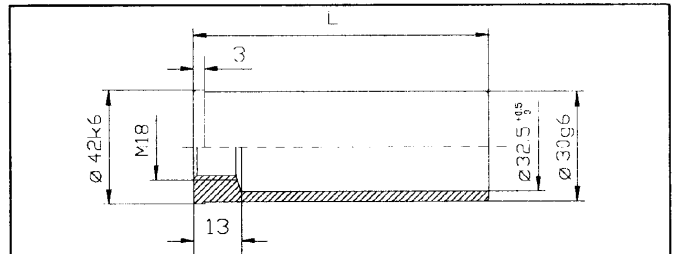

B90.042.LLL			
L	Nr	L	Nr
60	B90.042.060	140	B90.042.140
100	B90.042.100	160	B90.042.160
120	B90.042.120	180	B90.042.180

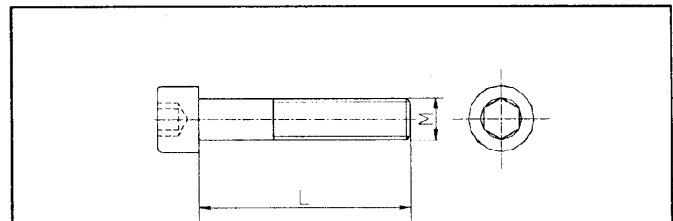

A05xxx.xxx					
M x L	Nr	M x L	Nr	M x L	Nr
10x25	A05.010.025	16x60	A05.016.060	16x140	A05.016.140
		16x65	A05.016.065	16x150	A05.016.150
		16x70	A05.016.070	16x160	A05.016.160
		16x80	A05.016.080	16x180	A05.016.180
16x30	A05.016.030	16x90	A05.016.090	16x200	A05.016.200
16x35	A05.016.035	16x100	A05.016.100	16x210	A05.016.210
16x45	A05.016.045	16x120	A05.016.120	16x220	A05.016.220
16x55	A05.016.055	16x130	A05.016.130	16x230	A05.016.230

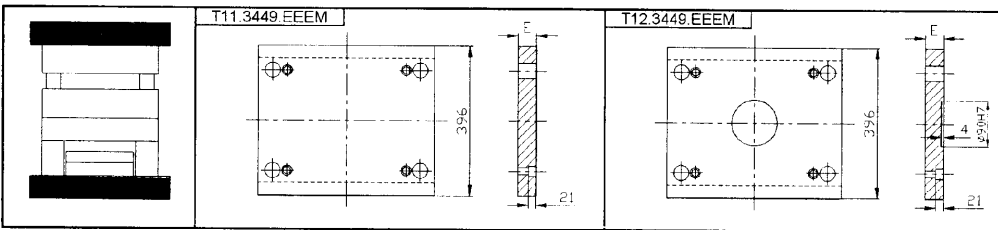
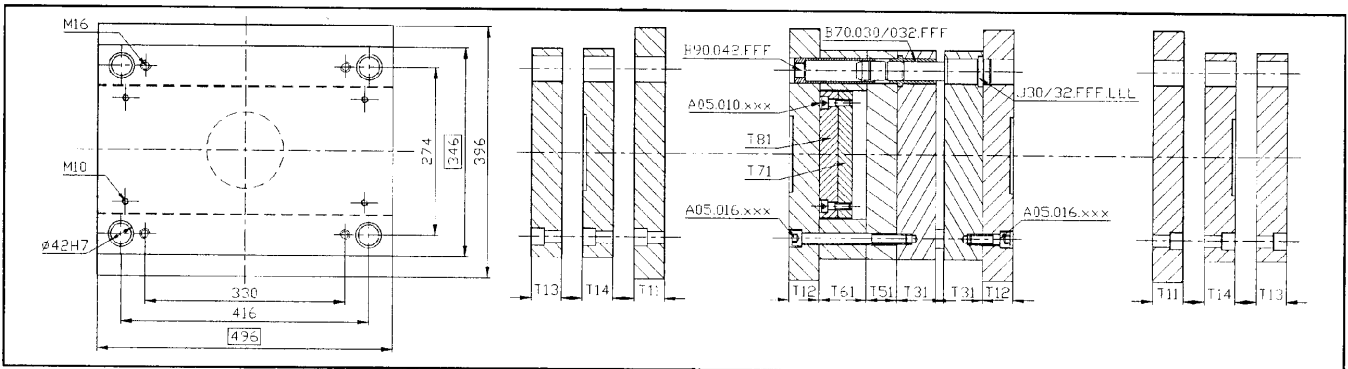

M	A	B	C	D	E
E	1730	2312	2311	2767	2162
27					
36					
46					

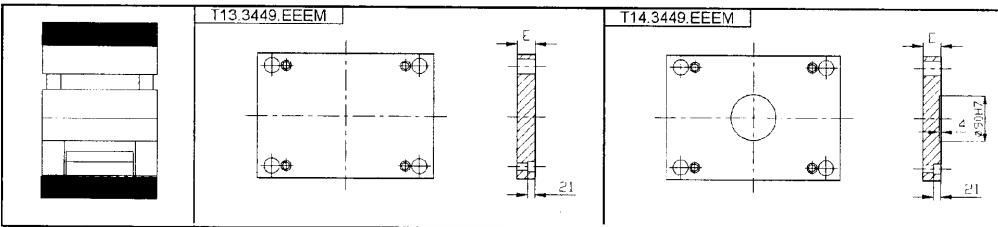

M	A	B	C	D	E
E	1730	2312	2311	2767	2162
22					
27					
36					

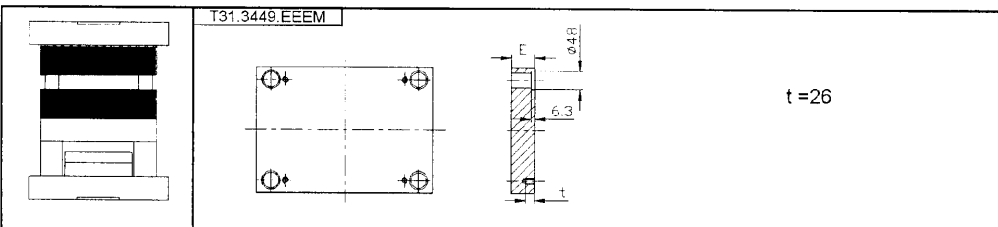

M	A	B	C	D	E
E	1730	2312	2311	2767	2162
36					
46					
56					
66					
76					
86					
96					
116					

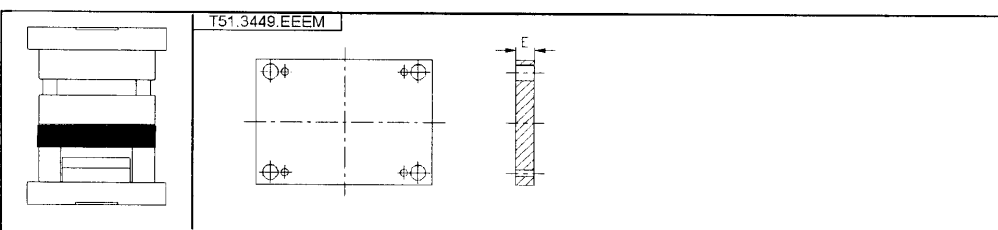

M	A	B	C	D	E
E	1730	2312	2311	2767	2162
36					
46					

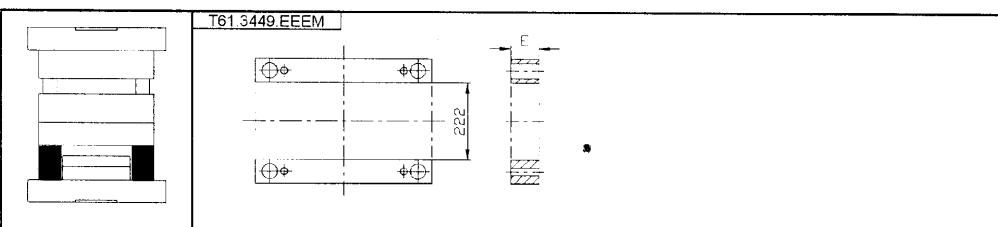

M	A	B	C	D	E
E	1730	2312	2311	2767	2162
58					
66					
76					
86					
96					
116					
136					

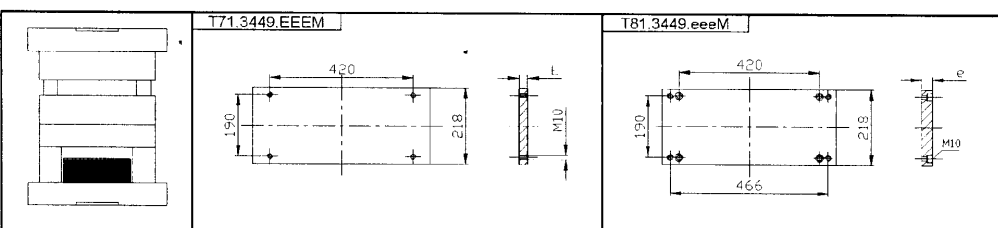

M	A	B	C	D	E
E	1730	2312	2311	2767	2162
17					



Ø 30 / Ø 32

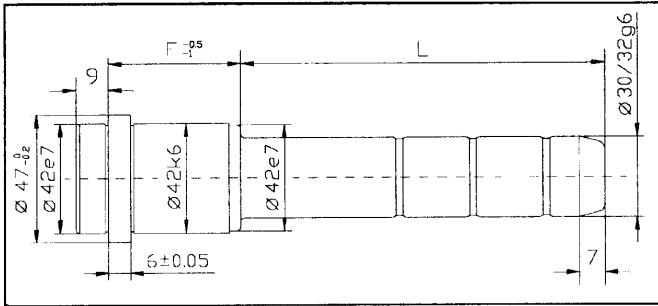
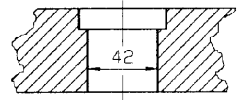

J30.FFF.LLL / J32.FFF.LLL

F	L	Nr ø / Ø	F	L	Nr ø / Ø	
36	55	J 30 / 32 .036 .055	76	55	J 30 / 32 .076 .055	
	75	J 30 / 32 .036 .075		75	J 30 / 32 .076 .075	
	95	J 30 / 32 .036 .095		95	J 30 / 32 .076 .095	
46	45	J 30 / 32 .046 .045	86	115	J 30 / 32 .076 .115	
	65	J 30 / 32 .046 .065		155	J 30 / 32 .076 .155	
	105	J 30 / 32 .046 .105		225	J 30 / 32 .076 .225	
	125	J 30 / 32 .046 .125		75	J 30 / 32 .086 .075	
	165	J 30 / 32 .046 .165		115	J 30 / 32 .086 .115	
56	245	J 30 / 32 .046 .245	116	155	J 30 / 32 .086 .155	
	55	J 30 / 32 .056 .055		136	75	J 30 / 32 .096 .075
	75	J 30 / 32 .056 .075			105	J 30 / 32 .096 .105
	105	J 30 / 32 .056 .105			75	J 30 / 32 .116 .075
	135	J 30 / 32 .056 .135			115	J 30 / 32 .116 .115
175	J 30 / 32 .056 .175	95	J 30 / 32 .136 .095			
66	245	J 30 / 32 .056 .245	156	115	J 30 / 32 .136 .115	
	55	J 30 / 32 .066 .055		115	J 30 / 32 .156 .115	
	75	J 30 / 32 .066 .075		155	J 30 / 32 .156 .155	
	95	J 30 / 32 .066 .095				
	135	J 30 / 32 .066 .135				
	175	J 30 / 32 .066 .175				
	245	J 30 / 32 .066 .245				

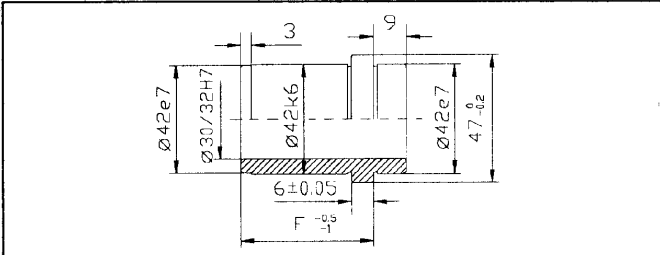

B70.030.OFF / B70.032.OFF

F	Nr ø / Ø	F	Nr ø / Ø
36	B70.0 30 / 32 .036	86	B70.0 30 / 32 .086
46	B70.0 30 / 32 .046	96	B70.0 30 / 32 .096
56	B70.0 30 / 32 .056	116	B70.0 30 / 32 .116
66	B70.0 30 / 32 .066	136	B70.0 30 / 32 .136
76	B70.0 30 / 32 .076	156	B70.0 30 / 32 .156

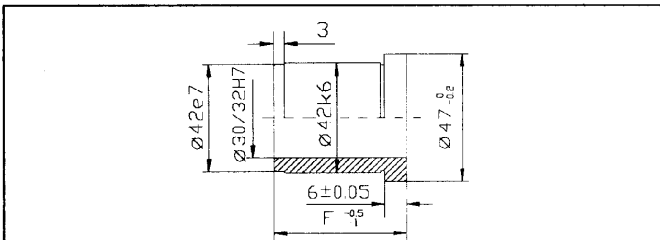

B80.030.OFF / B80.032.OFF

F	Nr ø / Ø	F	Nr ø / Ø
36	B80.0 30 / 32 .036	86	B80.0 30 / 32 .086
46	B80.0 30 / 32 .046	96	B80.0 30 / 32 .096
56	B80.0 30 / 32 .056	116	B80.0 30 / 32 .116
66	B80.0 30 / 32 .066	136	B80.0 30 / 32 .136
76	B80.0 30 / 32 .076	156	B80.0 30 / 32 .156

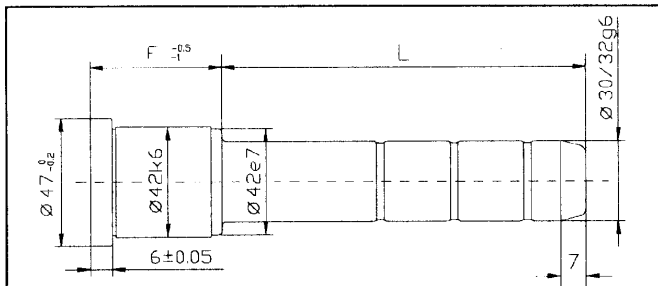

K30.FFF.LLL / K32.FFF.LLL

F	L	Nr ø / Ø	F	L	Nr ø / Ø
36	55	K 30 / 32 .036 .055	76	55	K 30 / 32 .076 .055
	75	K 30 / 32 .036 .075		75	K 30 / 32 .076 .075
	105	K 30 / 32 .036 .105		95	K 30 / 32 .076 .095
46	45	K 30 / 32 .046 .045	86	115	K 30 / 32 .076 .115
	65	K 30 / 32 .046 .065		75	K 30 / 32 .086 .075
	105	K 30 / 32 .046 .105		95	K 30 / 32 .086 .095
	125	K 30 / 32 .046 .125			
	165	K 30 / 32 .046 .165			
56	55	K 30 / 32 .056 .055	96	75	K 30 / 32 .096 .075
	75	K 30 / 32 .056 .075		105	K 30 / 32 .096 .105
	105	K 30 / 32 .056 .105		75	K 30 / 32 .116 .075
	135	K 30 / 32 .056 .135		115	K 30 / 32 .116 .105
	175	K 30 / 32 .056 .175		95	K 30 / 32 .136 .095
66	55	K 30 / 32 .066 .055	156	115	K 30 / 32 .136 .115
	75	K 30 / 32 .066 .075		115	K 30 / 32 .156 .115
	105	K 30 / 32 .066 .105			
	135	K 30 / 32 .066 .135			
	175	K 30 / 32 .066 .175			

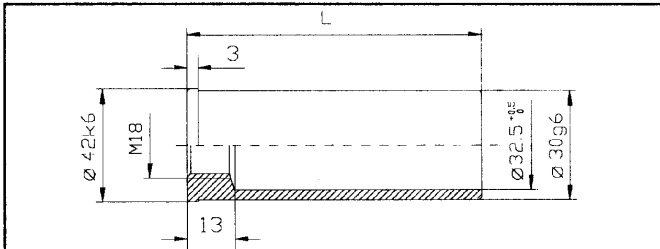

B90.042.LLL

L	Nr	L	Nr
60	B90.042.060	140	B90.042.140
100	B90.042.100	160	B90.042.160
120	B90.042.120	180	B90.042.180

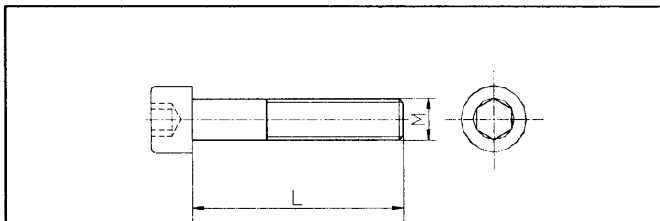

A05xxx.xxx

M x L	Nr	M x L	Nr	M x L	Nr
10x25	A05.010.025	16x60	A05.016.060	16x140	A05.016.140
		16x65	A05.016.065	16x150	A05.016.150
		16x70	A05.016.070	16x160	A05.016.160
		16x80	A05.016.080	16x180	A05.016.180
16x30	A05.016.030	16x90	A05.016.090	16x200	A05.016.200
16x35	A05.016.035	16x100	A05.016.100	16x210	A05.016.210
16x45	A05.016.045	16x120	A05.016.120	16x220	A05.016.220
16x55	A05.016.055	16x130	A05.016.130	16x230	A05.016.230

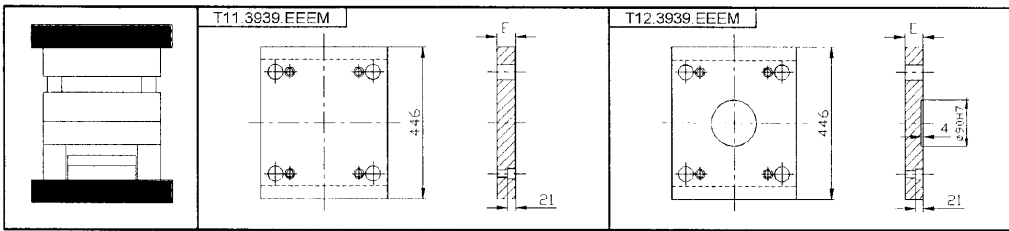
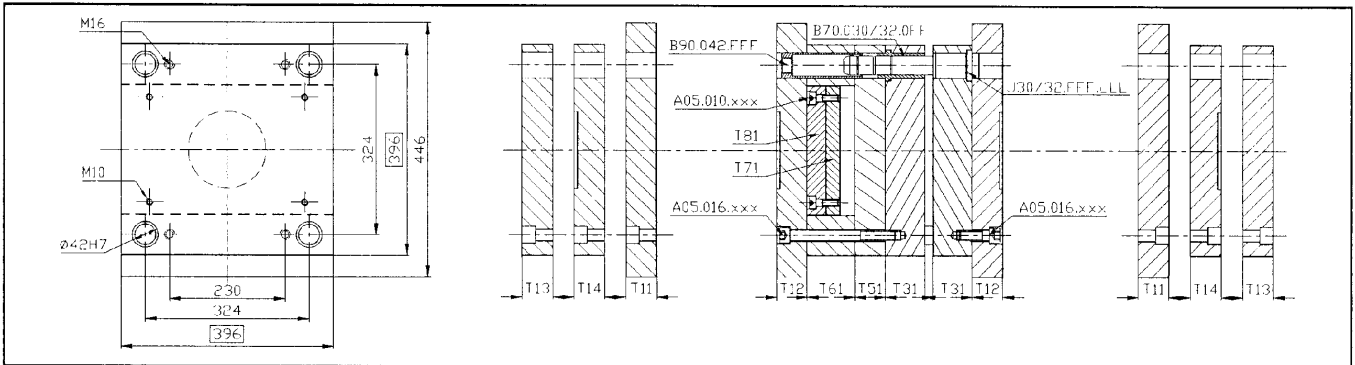

M	A	B	C	D	E
27	1730	2312	2311	2767	2162
36					
46					

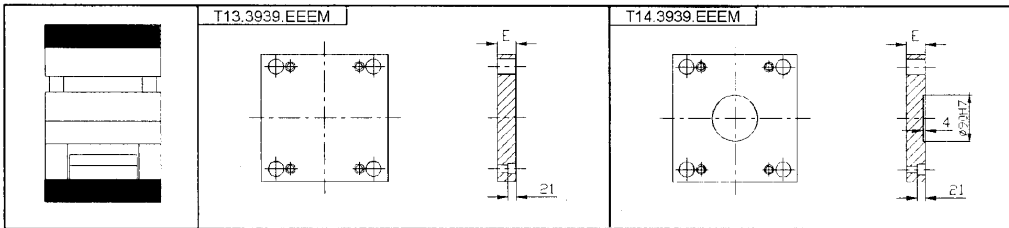

M	A	B	C	D	E
22	1730	2312	2311	2767	2162
27					
36					

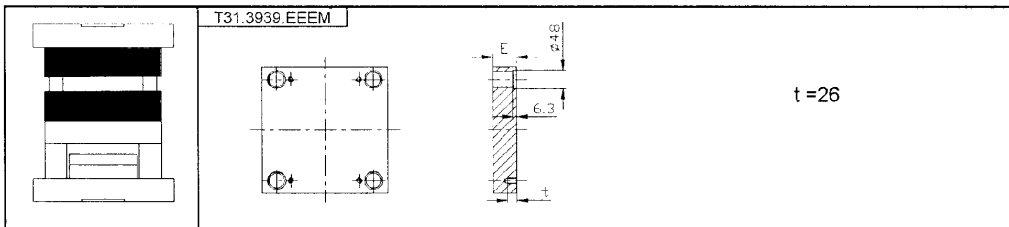

M	A	B	C	D	E
36	1730	2312	2311	2767	2162
46					
56					
66					
76					
86					
96					
116					

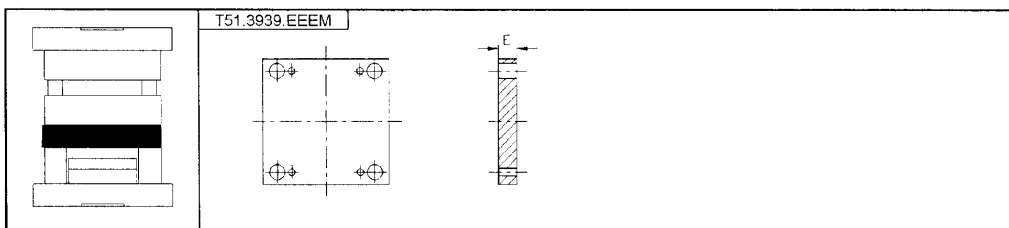

M	A	B	C	D	E
36	1730	2312	2311	2767	2162
46					

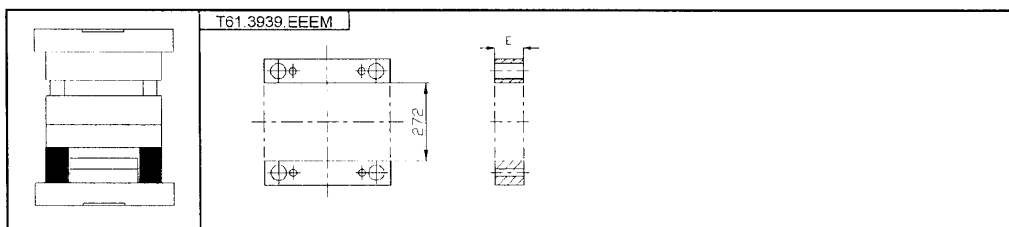

M	A	B	C	D	E
56	1730	2312	2311	2767	2162
66					
76					
86					
96					
116					

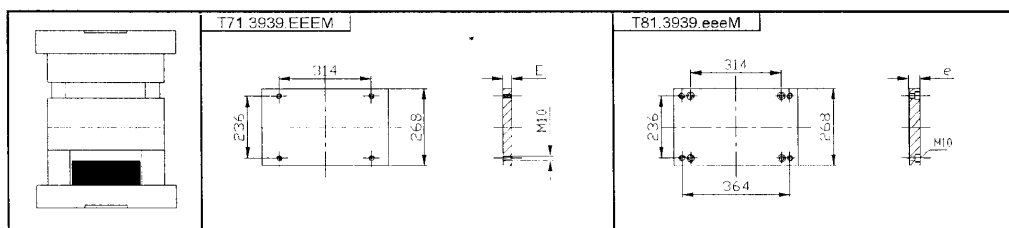

M	A	B	C	D	E
17	1730	2312	2311	2767	2162



∅ 30 / ∅ 32

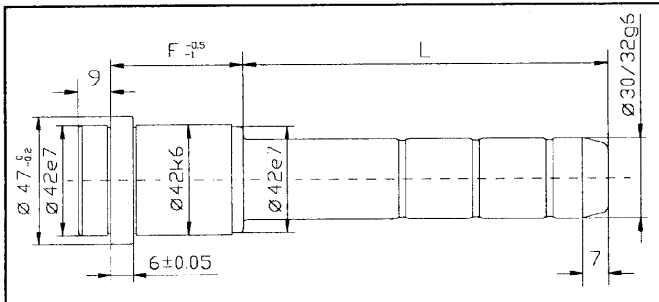
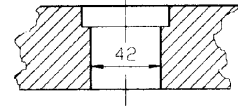

J30.FFF.LLL / J32.FFF.LLL					
F	L	Nr ∅ / ∅	F	L	Nr ∅ / ∅
36	55	J 30 / 32 036.055	76	55	J 30 / 32 076.055
	75	J 30 / 32 036.075		75	J 30 / 32 076.075
	95	J 30 / 32 036.095		95	J 30 / 32 076.095
46	45	J 30 / 32 046.045	86	115	J 30 / 32 076.115
	65	J 30 / 32 046.065		155	J 30 / 32 076.155
	105	J 30 / 32 046.105	96	225	J 30 / 32 076.225
	125	J 30 / 32 046.125		75	J 30 / 32 086.075
56	165	J 30 / 32 046.165	116	115	J 30 / 32 086.115
	245	J 30 / 32 046.245		155	J 30 / 32 086.155
	55	J 30 / 32 056.055	136	75	J 30 / 32 096.075
	75	J 30 / 32 056.075		105	J 30 / 32 096.105
	105	J 30 / 32 056.105	156	75	J 30 / 32 116.075
	135	J 30 / 32 056.135		115	J 30 / 32 116.115
66	175	J 30 / 32 056.175		95	J 30 / 32 136.095
	245	J 30 / 32 056.245		115	J 30 / 32 136.115
	55	J 30 / 32 066.055		115	J 30 / 32 156.115
	75	J 30 / 32 066.075		155	J 30 / 32 156.155
	95	J 30 / 32 066.095			

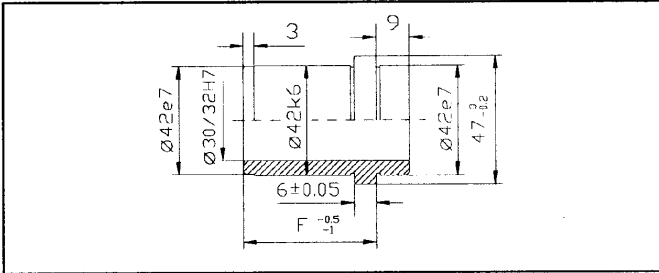

B70.030.OFF / B70.032.OFF			
F	Nr ∅ / ∅	F	Nr ∅ / ∅
36	B70.030/32 036	86	B70.030/32 086
46	B70.030/32 046	96	B70.030/32 096
56	B70.030/32 056	116	B70.030/32 116
66	B70.030/32 066	136	B70.030/32 136
76	B70.030/32 076	156	B70.030/32 156

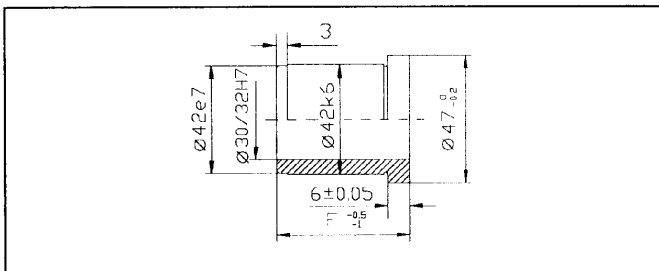

B80.030.OFF / B80.032.OFF			
F	Nr ∅ / ∅	F	Nr ∅ / ∅
36	B80.030/32 036	86	B80.030/32 086
46	B80.030/32 046	96	B80.030/32 096
56	B80.030/32 056	116	B80.030/32 116
66	B80.030/32 066	136	B80.030/32 136
76	B80.030/32 076	156	B80.030/32 156

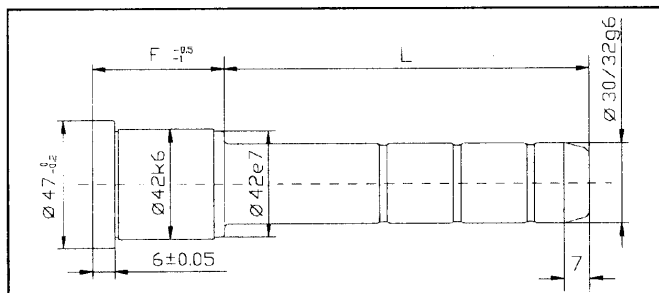

K30.FFF.LLL / K32.FFF.LLL					
F	L	Nr ∅ / ∅	F	L	Nr ∅ / ∅
36	55	K 30 / 32 036.055	76	55	K 30 / 32 076.055
	75	K 30 / 32 036.075		75	K 30 / 32 076.075
	105	K 30 / 32 036.105		95	K 30 / 32 076.095
46	45	K 30 / 32 046.045	86	115	K 30 / 32 076.115
	65	K 30 / 32 046.065			
	105	K 30 / 32 046.105	96	75	K 30 / 32 086.075
	125	K 30 / 32 046.125		95	K 30 / 32 086.095
56	165	K 30 / 32 046.165	116	75	K 30 / 32 096.075
	245	K 30 / 32 046.245		105	K 30 / 32 096.105
	55	K 30 / 32 056.055	136	75	K 30 / 32 116.075
	75	K 30 / 32 056.075		115	K 30 / 32 116.105
	105	K 30 / 32 056.105	156	95	K 30 / 32 136.095
	135	K 30 / 32 056.135		115	K 30 / 32 136.115
66	175	K 30 / 32 056.175		115	K 30 / 32 156.115
	55	K 30 / 32 066.055			
	75	K 30 / 32 066.075			
	105	K 30 / 32 066.105			
	135	K 30 / 32 066.135			

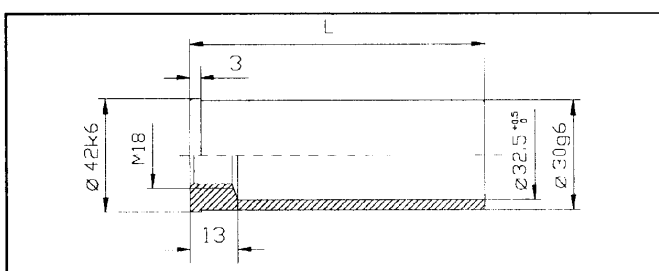

B90.042.LLL					
L	Nr	L	Nr	L	Nr
60	B90.042.060	140	B90.042.140		
100	B90.042.100	160	B90.042.160		
120	B90.042.120	180	B90.042.180		

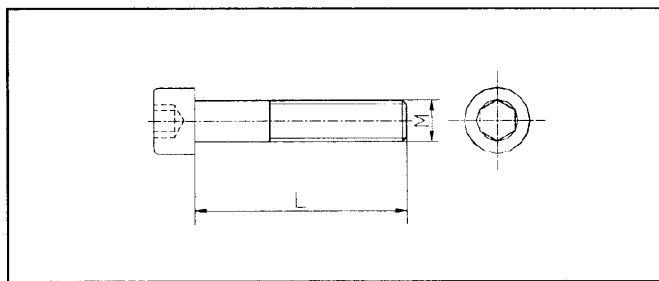

A05xxx.xxx					
M x L	Nr	M x L	Nr	M x L	Nr
10x25	A05.010.025	16x60	A05.016.060	16x140	A05.016.140
		16x65	A05.016.065	16x150	A05.016.150
		16x70	A05.016.070	16x160	A05.016.160
16x30	A05.016.030	16x80	A05.016.080	16x180	A05.016.180
		16x90	A05.016.090	16x200	A05.016.200
		16x100	A05.016.100	16x210	A05.016.210
16x35	A05.016.035	16x120	A05.016.120	16x220	A05.016.220
16x45	A05.016.045	16x130	A05.016.130	16x230	A05.016.230
16x55	A05.016.055				

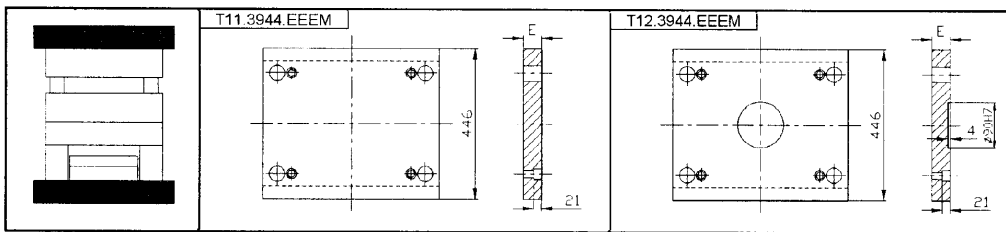
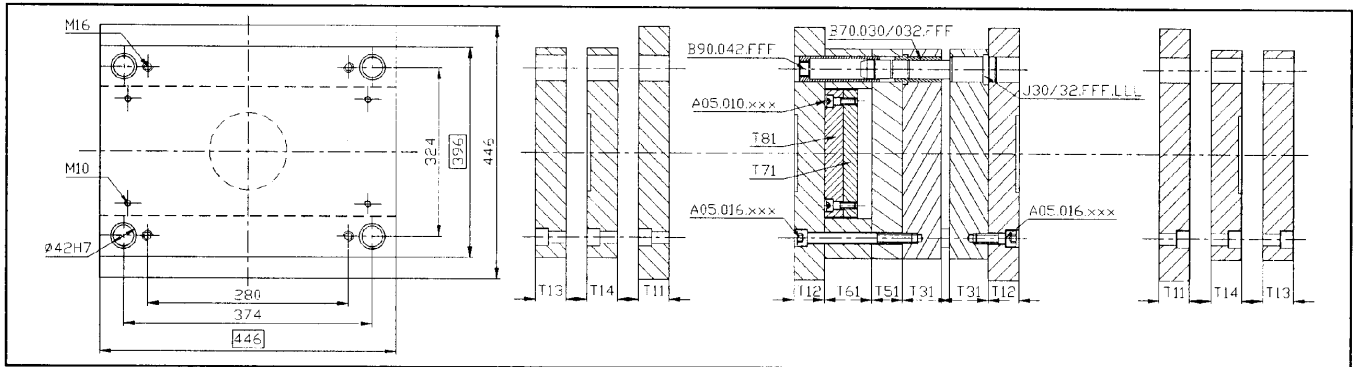

M	A	B	C	D	E
E	1730	2312	2311	2767	2162
27					
36					
46					

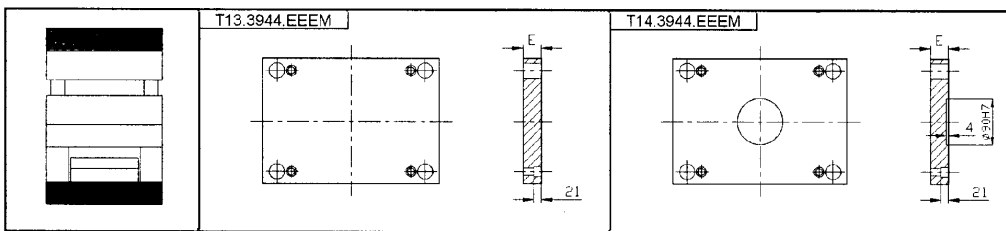

M	A	B	C	D	E
E	1730	2312	2311	2767	2162
27					
36					

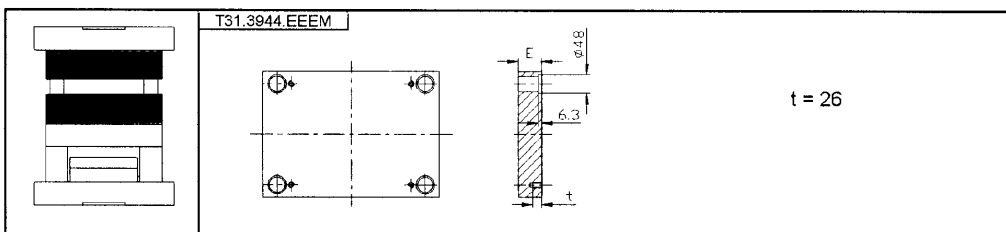

M	A	B	C	D	E
E	1730	2312	2311	2767	2162
36					
46					
56					
66					
76					
86					
96					
116					

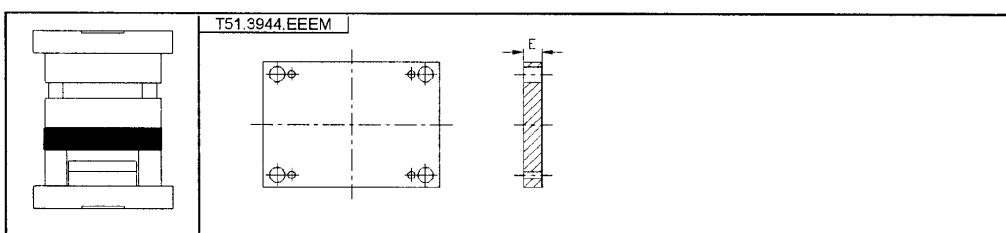

M	A	B	C	D	E
E	1730	2312	2311	2767	2162
36					
46					

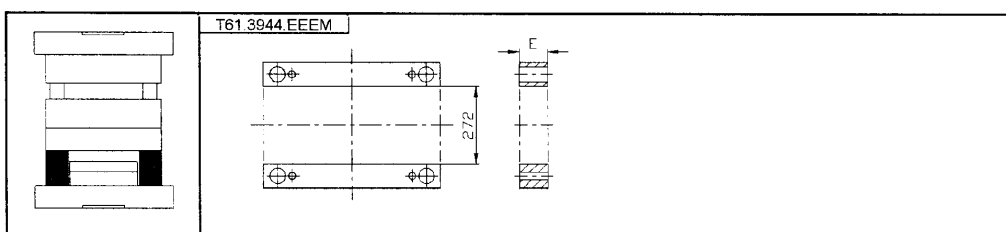

M	A	B	C	D	E
E	1730	2312	2311	2767	2162
56					
66					
76					
86					
96					
116					

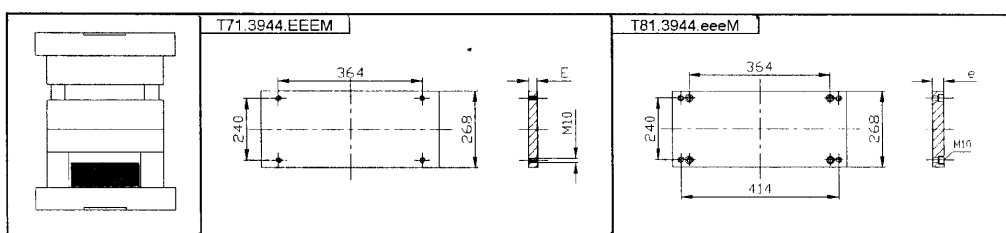

M	A	B	C	D	E
E	1730	2312	2311	2767	2162
17					

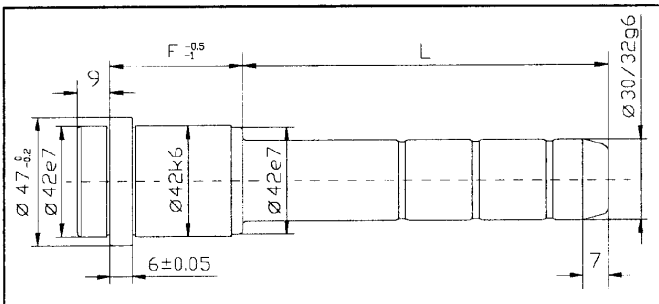
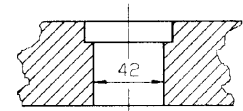

J30.FFF.LLL / J32.FFF.LLL					
F	L	Nr ∅ / ∅	F	L	Nr ∅ / ∅
36	55	J 30 / 32 .036.055	76	55	J 30 / 32 .076.055
	75	J 30 / 32 .036.075		75	J 30 / 32 .076.075
	95	J 30 / 32 .036.095		95	J 30 / 32 .076.095
46	45	J 30 / 32 .046.045	86	115	J 30 / 32 .076.115
	65	J 30 / 32 .046.065		155	J 30 / 32 .076.155
	105	J 30 / 32 .046.105		225	J 30 / 32 .076.225
	125	J 30 / 32 .046.125	75	J 30 / 32 .086.075	
	165	J 30 / 32 .046.165	115	J 30 / 32 .086.115	
56	245	J 30 / 32 .046.245	96	155	J 30 / 32 .086.155
	55	J 30 / 32 .056.055		75	J 30 / 32 .096.075
	75	J 30 / 32 .056.075		105	J 30 / 32 .096.105
	105	J 30 / 32 .056.105	116	75	J 30 / 32 .116.075
	135	J 30 / 32 .056.135	115	J 30 / 32 .116.115	
66	175	J 30 / 32 .056.175	136	95	J 30 / 32 .136.095
	245	J 30 / 32 .056.245		115	J 30 / 32 .136.115
	55	J 30 / 32 .066.055		156	115
	75	J 30 / 32 .066.075	155	J 30 / 32 .156.155	
	95	J 30 / 32 .066.095			
	135	J 30 / 32 .066.135			
	175	J 30 / 32 .066.175			
	245	J 30 / 32 .066.245			

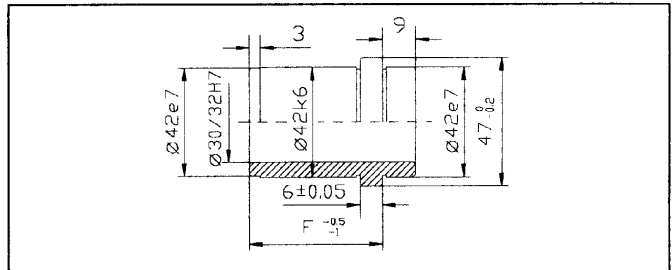

B70.030.OFF / B70.032.OFF			
F	Nr ∅ / ∅	F	Nr ∅ / ∅
36	B70.030/32.036	66	B70.030/32.066
46	B70.030/32.046	96	B70.030/32.096
56	B70.030/32.056	116	B70.030/32.116
66	B70.030/32.066	136	B70.030/32.136
76	B70.030/32.076	156	B70.030/32.156

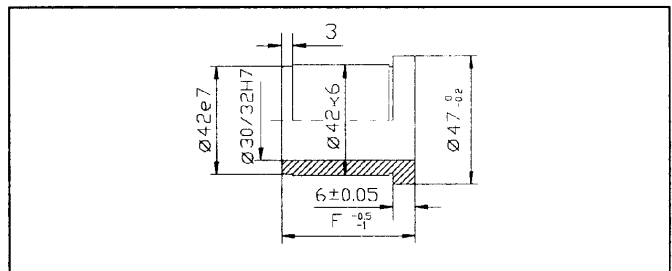

B80.030.OFF / B80.032.OFF			
F	Nr ∅ / ∅	F	Nr ∅ / ∅
36	B80.030/32.036	66	B80.030/32.066
46	B80.030/32.046	96	B80.030/32.096
56	B80.030/32.056	116	B80.030/32.116
66	B80.030/32.066	136	B80.030/32.136
76	B80.030/32.076	156	B80.030/32.156

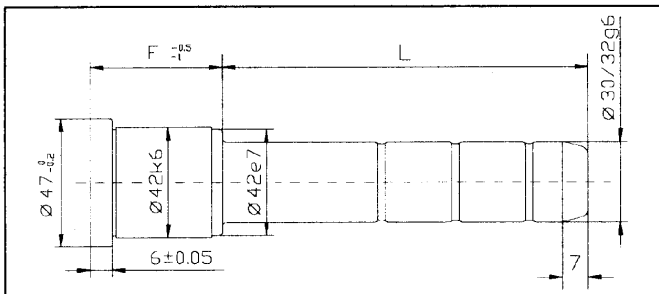

K30.FFF.LLL / K32.FFF.LLL					
F	L	Nr ∅ / ∅	F	L	Nr ∅ / ∅
36	55	K 30 / 32 .036.055	76	55	K 30 / 32 .076.055
	75	K 30 / 32 .036.075		75	K 30 / 32 .076.075
	105	K 30 / 32 .036.105		95	K 30 / 32 .076.095
46	45	K 30 / 32 .046.045	86	115	K 30 / 32 .076.115
	65	K 30 / 32 .046.065		75	K 30 / 32 .086.075
	105	K 30 / 32 .046.105		95	K 30 / 32 .086.095
56	125	K 30 / 32 .046.125	96	75	K 30 / 32 .096.075
	165	K 30 / 32 .046.165		75	K 30 / 32 .096.075
	55	K 30 / 32 .056.055		105	K 30 / 32 .096.105
	75	K 30 / 32 .056.075	116	75	K 30 / 32 .116.075
	105	K 30 / 32 .056.105	115	K 30 / 32 .116.105	
66	135	K 30 / 32 .056.135	136	95	K 30 / 32 .136.095
	175	K 30 / 32 .056.175		115	K 30 / 32 .136.115
	55	K 30 / 32 .066.055		156	115
	75	K 30 / 32 .066.075			
	105	K 30 / 32 .066.105			
	135	K 30 / 32 .066.135			
	175	K 30 / 32 .066.175			

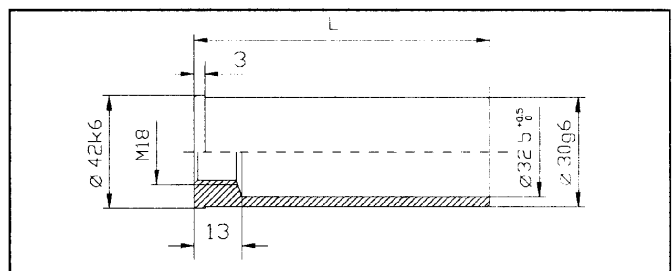

B90.042.LLL			
L	Nr	L	Nr
60	B90.042.060	140	B90.042.140
100	B90.042.100	160	B90.042.160
120	B90.042.120	180	B90.042.180

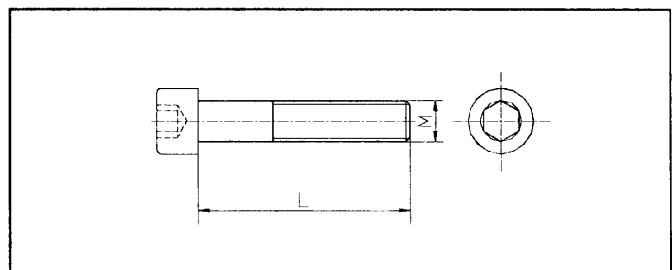

A05xxx xxx					
M x L	Nr	M x L	Nr	M x L	Nr
10x25	A05.010.025	16x60	A05.016.060	16x140	A05.016.140
		16x65	A05.016.065	16x150	A05.016.150
		16x70	A05.016.070	16x160	A05.016.160
16x30	A05.016.030	16x80	A05.016.080	16x180	A05.016.180
		16x90	A05.016.090	16x200	A05.016.200
		16x100	A05.016.100	16x210	A05.016.210
16x35	A05.016.035	16x120	A05.016.120	16x220	A05.016.220
16x45	A05.016.045	16x130	A05.016.130	16x230	A05.016.230
16x55	A05.016.055				

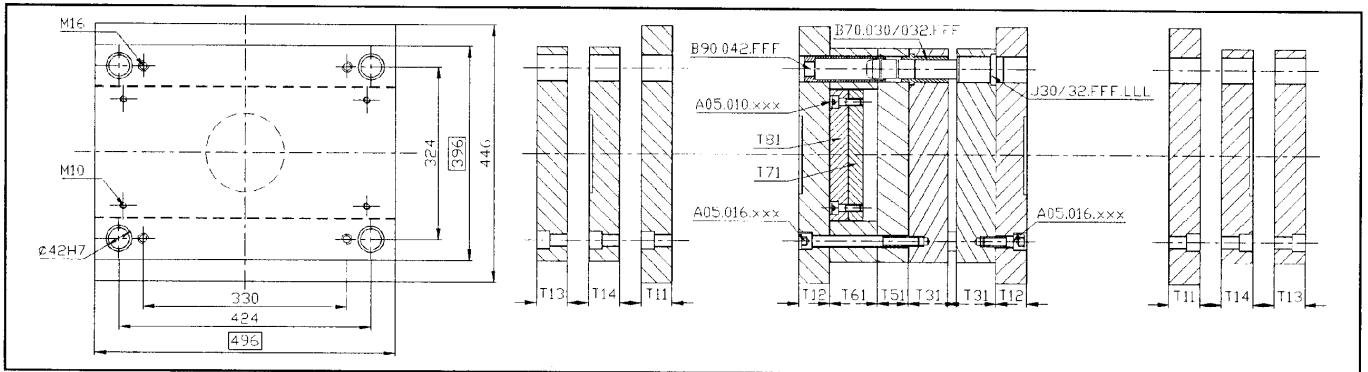

	<b>T11.3949.EEEM</b>			<b>T12.3949.EEEM</b>			<table border="1"> <tr><th>M</th><th>A</th><th>B</th><th>C</th><th>D</th><th>E</th></tr> <tr><td>E</td><td>1730</td><td>2312</td><td>2311</td><td>2767</td><td>2162</td></tr> <tr><td>36</td><td></td><td></td><td></td><td></td><td></td></tr> <tr><td>46</td><td></td><td></td><td></td><td></td><td></td></tr> <tr><td></td><td></td><td></td><td></td><td></td><td></td></tr> <tr><td></td><td></td><td></td><td></td><td></td><td></td></tr> <tr><td></td><td></td><td></td><td></td><td></td><td></td></tr> <tr><td></td><td></td><td></td><td></td><td></td><td></td></tr> <tr><td></td><td></td><td></td><td></td><td></td><td></td></tr> <tr><td></td><td></td><td></td><td></td><td></td><td></td></tr> <tr><td></td><td></td><td></td><td></td><td></td><td></td></tr> </table>	M	A	B	C	D	E	E	1730	2312	2311	2767	2162	36						46																																															
	M	A	B	C	D	E																																																																			
E	1730	2312	2311	2767	2162																																																																				
36																																																																									
46																																																																									

	<b>T13.3949.EEEM</b>			<b>T14.3949.EEEM</b>			<table border="1"> <tr><th>M</th><th>A</th><th>B</th><th>C</th><th>D</th><th>E</th></tr> <tr><td>E</td><td>1730</td><td>2312</td><td>2311</td><td>2767</td><td>2162</td></tr> <tr><td>27</td><td></td><td></td><td></td><td></td><td></td></tr> <tr><td>36</td><td></td><td></td><td></td><td></td><td></td></tr> <tr><td></td><td></td><td></td><td></td><td></td><td></td></tr> <tr><td></td><td></td><td></td><td></td><td></td><td></td></tr> <tr><td></td><td></td><td></td><td></td><td></td><td></td></tr> <tr><td></td><td></td><td></td><td></td><td></td><td></td></tr> <tr><td></td><td></td><td></td><td></td><td></td><td></td></tr> <tr><td></td><td></td><td></td><td></td><td></td><td></td></tr> <tr><td></td><td></td><td></td><td></td><td></td><td></td></tr> </table>	M	A	B	C	D	E	E	1730	2312	2311	2767	2162	27						36																																															
	M	A	B	C	D	E																																																																			
E	1730	2312	2311	2767	2162																																																																				
27																																																																									
36																																																																									

	<b>T31.3949.EEEM</b>			<b>t = 26</b>	<table border="1"> <tr><th>M</th><th>A</th><th>B</th><th>C</th><th>D</th><th>E</th></tr> <tr><td>E</td><td>1730</td><td>2312</td><td>2311</td><td>2767</td><td>2162</td></tr> <tr><td>36</td><td></td><td></td><td></td><td></td><td></td></tr> <tr><td>46</td><td></td><td></td><td></td><td></td><td></td></tr> <tr><td>56</td><td></td><td></td><td></td><td></td><td></td></tr> <tr><td>66</td><td></td><td></td><td></td><td></td><td></td></tr> <tr><td>76</td><td></td><td></td><td></td><td></td><td></td></tr> <tr><td>86</td><td></td><td></td><td></td><td></td><td></td></tr> <tr><td>96</td><td></td><td></td><td></td><td></td><td></td></tr> <tr><td>116</td><td></td><td></td><td></td><td></td><td></td></tr> <tr><td>136</td><td></td><td></td><td></td><td></td><td></td></tr> </table>	M	A	B	C	D	E	E	1730	2312	2311	2767	2162	36						46						56						66						76						86						96						116						136					
	M	A	B	C		D	E																																																																
E	1730	2312	2311	2767	2162																																																																		
36																																																																							
46																																																																							
56																																																																							
66																																																																							
76																																																																							
86																																																																							
96																																																																							
116																																																																							
136																																																																							

	<b>T51.3949.EEEM</b>			<table border="1"> <tr><th>M</th><th>A</th><th>B</th><th>C</th><th>D</th><th>E</th></tr> <tr><td>E</td><td>1730</td><td>2312</td><td>2311</td><td>2767</td><td>2162</td></tr> <tr><td>36</td><td></td><td></td><td></td><td></td><td></td></tr> <tr><td>46</td><td></td><td></td><td></td><td></td><td></td></tr> <tr><td></td><td></td><td></td><td></td><td></td><td></td></tr> <tr><td></td><td></td><td></td><td></td><td></td><td></td></tr> <tr><td></td><td></td><td></td><td></td><td></td><td></td></tr> <tr><td></td><td></td><td></td><td></td><td></td><td></td></tr> <tr><td></td><td></td><td></td><td></td><td></td><td></td></tr> <tr><td></td><td></td><td></td><td></td><td></td><td></td></tr> <tr><td></td><td></td><td></td><td></td><td></td><td></td></tr> </table>	M	A	B	C	D	E	E	1730	2312	2311	2767	2162	36						46																																															
	M	A	B		C	D	E																																																															
E	1730	2312	2311	2767	2162																																																																	
36																																																																						
46																																																																						

	<b>T61.3949.EEEM</b>			<table border="1"> <tr><th>M</th><th>A</th><th>B</th><th>C</th><th>D</th><th>E</th></tr> <tr><td>E</td><td>1730</td><td>2312</td><td>2311</td><td>2767</td><td>2162</td></tr> <tr><td>66</td><td></td><td></td><td></td><td></td><td></td></tr> <tr><td>76</td><td></td><td></td><td></td><td></td><td></td></tr> <tr><td>86</td><td></td><td></td><td></td><td></td><td></td></tr> <tr><td>96</td><td></td><td></td><td></td><td></td><td></td></tr> <tr><td>116</td><td></td><td></td><td></td><td></td><td></td></tr> <tr><td>136</td><td></td><td></td><td></td><td></td><td></td></tr> </table>	M	A	B	C	D	E	E	1730	2312	2311	2767	2162	66						76						86						96						116						136					
	M	A	B		C	D	E																																													
E	1730	2312	2311	2767	2162																																															
66																																																				
76																																																				
86																																																				
96																																																				
116																																																				
136																																																				

	<b>T71.3949.EEEM</b>			<b>T81.3949.eeeM</b>			<table border="1"> <tr><th>M</th><th>A</th><th>B</th><th>C</th><th>D</th><th>E</th></tr> <tr><td>E</td><td>1730</td><td>2312</td><td>2311</td><td>2767</td><td>2162</td></tr> <tr><td>22</td><td></td><td></td><td></td><td></td><td></td></tr> </table> <table border="1"> <tr><th>M</th><th>A</th><th>B</th><th>C</th><th>D</th><th>E</th></tr> <tr><td>e</td><td>1730</td><td>2312</td><td>2311</td><td>2767</td><td>2162</td></tr> <tr><td>27</td><td></td><td></td><td></td><td></td><td></td></tr> </table>	M	A	B	C	D	E	E	1730	2312	2311	2767	2162	22						M	A	B	C	D	E	e	1730	2312	2311	2767	2162	27					
	M	A	B	C	D	E																																					
E	1730	2312	2311	2767	2162																																						
22																																											
M	A	B	C	D	E																																						
e	1730	2312	2311	2767	2162																																						
27																																											



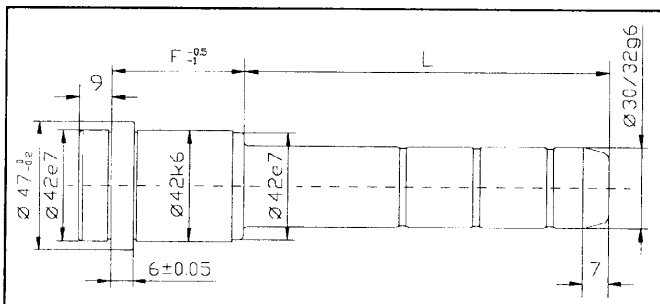
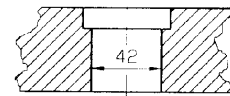

J30.FFF.LLL / J32.FFF.LLL					
F	L	Nr ∅ / ∅	F	L	Nr ∅ / ∅
36	55	J 30 / 32 .036.055	76	55	J 30 / 32 .076.055
	75	J 30 / 32 .036.075		75	J 30 / 32 .076.075
	95	J 30 / 32 .036.095		95	J 30 / 32 .076.095
46	45	J 30 / 32 .046.045	86	115	J 30 / 32 .076.115
	65	J 30 / 32 .046.065		155	J 30 / 32 .076.155
	105	J 30 / 32 .046.105		225	J 30 / 32 .076.225
	125	J 30 / 32 .046.125		75	J 30 / 32 .086.075
	185	J 30 / 32 .046.185		115	J 30 / 32 .086.115
56	245	J 30 / 32 .046.245	96	155	J 30 / 32 .086.155
	55	J 30 / 32 .056.055		75	J 30 / 32 .096.075
	75	J 30 / 32 .056.075		105	J 30 / 32 .096.105
	105	J 30 / 32 .056.105		115	J 30 / 32 .116.075
	135	J 30 / 32 .056.135		136	95
66	175	J 30 / 32 .056.175	156	115	J 30 / 32 .136.115
	55	J 30 / 32 .066.055		115	J 30 / 32 .156.115
	75	J 30 / 32 .066.075		155	J 30 / 32 .156.155
	95	J 30 / 32 .066.095			
	135	J 30 / 32 .066.135			
	175	J 30 / 32 .066.175			
	245	J 30 / 32 .066.245			

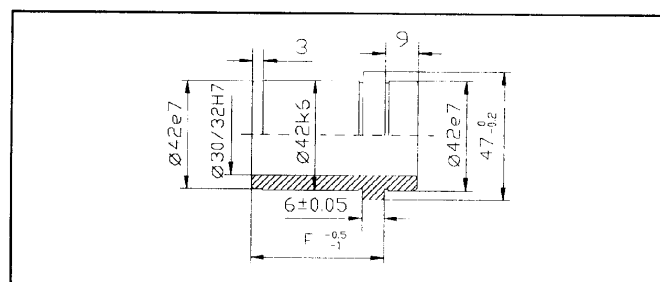

B70.030.OFF / B70.032.OFF			
F	Nr ∅ / ∅	F	Nr ∅ / ∅
36	B70.030/32.036	86	B70.030/32.086
46	B70.030/32.046	96	B70.030/32.096
56	B70.030/32.056	116	B70.030/32.116
66	B70.030/32.066	136	B70.030/32.136
76	B70.030/32.076	156	B70.030/32.156

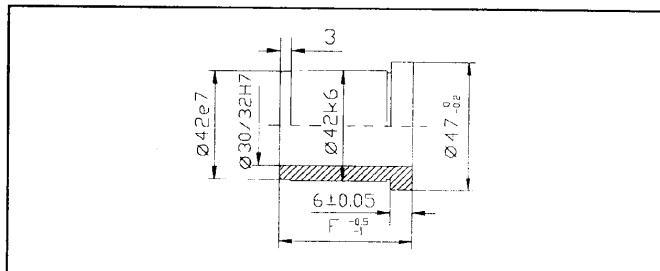

B80.030.OFF / B80.032.OFF			
F	Nr ∅ / ∅	F	Nr ∅ / ∅
36	B80.030/32.036	86	B80.030/32.086
46	B80.030/32.046	96	B80.030/32.096
56	B80.030/32.056	116	B80.030/32.116
66	B80.030/32.066	136	B80.030/32.136
76	B80.030/32.076	156	B80.030/32.156

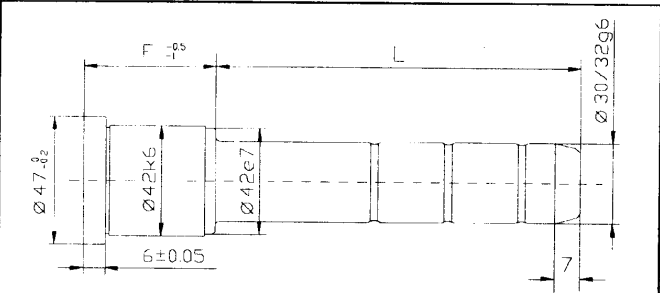

K30.FFF.LLL / K32.FFF.LLL						
F	L	Nr ∅ / ∅	F	L	Nr ∅ / ∅	
36	55	K 30 / 32 .036.055	76	55	K 30 / 32 .076.055	
	75	K 30 / 32 .036.075		75	K 30 / 32 .076.075	
	95	K 30 / 32 .036.095		95	K 30 / 32 .076.095	
46	45	K 30 / 32 .046.045	86	115	K 30 / 32 .076.115	
	65	K 30 / 32 .046.065				
	105	K 30 / 32 .046.105				
56	125	K 30 / 32 .046.125	96	75	K 30 / 32 .086.075	
	165	K 30 / 32 .046.165		95	K 30 / 32 .086.095	
	55	K 30 / 32 .056.055		116	75	K 30 / 32 .096.075
	75	K 30 / 32 .056.075			105	K 30 / 32 .096.105
	105	K 30 / 32 .056.105			115	K 30 / 32 .116.075
66	135	K 30 / 32 .056.135	136	115	K 30 / 32 .116.105	
	175	K 30 / 32 .056.175		95	K 30 / 32 .136.095	
	55	K 30 / 32 .066.055		156	115	K 30 / 32 .136.115
	75	K 30 / 32 .066.075			115	K 30 / 32 .156.115
	105	K 30 / 32 .066.105				
	135	K 30 / 32 .066.135				
	175	K 30 / 32 .066.175				

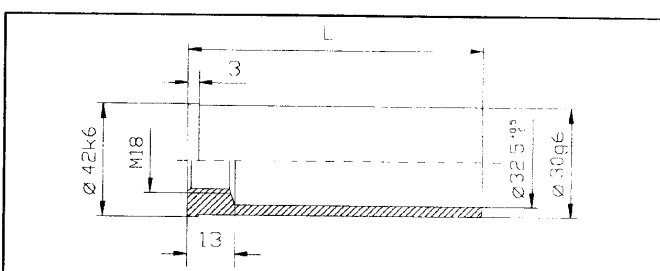

B90.042.LLL			
L	Nr	L	Nr
60	B90.042.060	140	B90.042.140
100	B90.042.100	160	B90.042.160
120	B90.042.120	180	B90.042.180

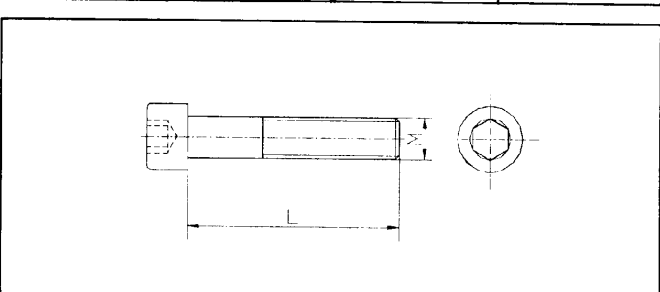

A05xxx.xxx					
M x L	Nr	M x L	Nr	M x L	Nr
10x30	A05.010.025	16x60	A05.016.060	16x140	A05.016.140
		16x65	A05.016.065	16x150	A05.016.150
		16x70	A05.016.070	16x160	A05.016.160
		16x80	A05.016.080	16x180	A05.016.180
16x30	A05.016.030	16x90	A05.016.090	16x200	A05.016.200
16x35	A05.016.035	16x100	A05.016.100	16x210	A05.016.210
16x45	A05.016.045	16x120	A05.016.120	16x220	A05.016.220
16x55	A05.016.055	16x130	A05.016.130	16x230	A05.016.230